



**gebo**original

**THINGS TO KNOW ABOUT OUR CAST MALLEABLE IRON COMPRESSION FITTINGS, SERIES 150, 220, 153/155****GEBO SPECIAL COMPRESSION FITTINGS AND FLANGES:**

- designed for continuous operation
- restrained, that means resistant to tensile and shearing strength
- bending possible up to 3°, for couplings 2 x 3° = 6°
- suitable as potential balancing
- save time as they do not require threading or welding

**MATERIALS USED:****FITTING BODY:**

malleable cast iron EN-GJMB 350-10, EN 1562

**CONE NUT/FLANGE:**

malleable cast iron EN-GJMB 350-10, EN 1562

**COMPRESSION RING:**

galvanised steel or brass (partly used in malleable cast iron compression fittings for PE and black steel pipes)

**WASHER:**

galvanized steel

**SEALING RING:**

NBR

**GALVANIZATION:**

hot dip galvanizing of fitting bodies, flange plates and cone nuts (hot dip galvanizing according to DIN EN 10242).

Surfaces exposed during machining are galvanized.

Steel compression rings and washers are also galvanized.

**CONNECTING THREAD:** According to ISO 7/1 or EN 10226/1

**AREAS OF APPLICATION:**

Repairs to existing pipelines and the construction of new systems for the following media: water, compressed air, heating oil (according to DIN 51603-1), gases according to work sheet DVGW G 260

**Malleable cast iron compression fittings for steel pipes:****FOR STEEL PIPES**

DIN EN 10255 and DIN EN 10220 series 1

**TYPICAL AREAS OF APPLICATION:**

- water systems
- domestic connection lines in the gas and water supply
- fire extinguisher lines
- compressed air pipes
- filling lines for heating oil

**Malleable cast iron compression fittings for black steel pipes:****FOR BLACK STEEL PIPES**

DIN EN 10220 series 2 and 3

**TYPICAL AREAS OF APPLICATION:**

- heating systems
- filling lines for heating oil

**Malleable cast iron compression fittings for PE pipes:****FOR PE PIPES**

PE 80, PE 100, PE-Xa pipes (each SDR 11) according to DVGW – working sheet GW 335 A2/A3 as well as DIN 8074/75, DIN EN 12201-2 and DIN 16893

**TYPICAL AREAS OF APPLICATION:**

- Domestic connection lines in the gas and water supply

<b>TYPES A and AF</b>	<b>MALLEABLE CAST IRON COMPRESSION FITTINGS WITH MALE THREAD</b>
<b>FOR STEEL PIPES</b>	DIN EN 10255 and DIN EN 10220 series 1

**MEDIA:** water, compressed air, heating oil up to 2" (observe the regulations for flammable liquids!), for gas (outside buildings)

**OPERATING TEMPERATURE:** water: up to 25°C, heating water: up to 80°C, heating oil: 40°C; gas: -20°C to +60°C, compressed air: max. 70°C.



**SERIES 150:**  
17.2 MM - 60.3 MM

**PRESSURE STAGES:**

water PN 10 (up to 3/4") or PN 16 (from 1"),  
compressed air PN 12.5, oil PN 6, gas PN 5, fire extinguisher lines (VdS) PN 12.5

**TESTS/APPROVALS:**

water: DVGW W 534, DVGW Reg. No.: DW-8511AU2216;  
fire extinguisher lines: (from size DN25 onwards) - VdS-tested  
heating oil: Building approval DIBT, approval no.: Z-38.4-212  
gas: DIN 3387-1, DVGW Reg. No.: NG-4502AP1454  
technical approval national certificates  
hygienic certificate: national certificates



**SERIES 220:**  
76.1 MM - 114.3 MM

**PRESSURE STAGES:**

water PN 16,  
compressed air PN 10, fire extinguisher lines (VdS) PN 16,  
gas PN 5

**TESTS/APPROVALS:**

water: DVGW W 534, DVGW Reg. No.: DW-8511AU2217;  
fire extinguisher lines: VdS-tested  
gas: DIN 3387-1, DVGW Reg. No.: NG-4502AP1491  
technical approval national certificates  
hygienic certificate: national certificates

DN	Connecting thread x pipe outer-Ø [mm]	Code
10	3/8" x 17.2	01.150.00.00
15	1/2" x 21.3	01.150.00.01
20	3/4" x 26.9	01.150.00.02
25	1" x 33.7	01.150.00.03
32	1 1/4" x 42.4	01.150.00.04
40	1 1/2" x 48.3	01.150.00.05
50	2" x 60.3	01.150.00.06
65	2 1/2" x 76.1	01.220.00.07
80	3" x 88.9	01.220.00.08
100	4" x 114.3	01.220.00.09

<b>TYPES A and AF</b>	<b>MALLEABLE CAST IRON COMPRESSION FITTINGS WITH MALE THREAD</b>
<b>FOR BLACK STEEL PIPES</b>	DIN EN 10220 series 2 and 3

**MEDIA:** water, compressed air, heating oil only 57 mm (observe regulations for flammable liquids!)

**TEMPERATURES:** heating water: up to 80°C; oil: 40°C

**SERIES 150:**  
20 MM - 63.5 MM

**PRESSURE STAGES:**

water PN 6,  
compressed air PN 12.5,  
oil PN 6

**TESTS/APPROVALS:**

heating oil: for 57 mm - building approval DIBT, approval no.: Z-38.4-212  
technical approval national certificates

**SERIES 220:**  
70 MM - 108 MM

**PRESSURE STAGES:**

water PN 6,  
compressed air PN 10



DN	Connecting thread x pipe outer-Ø [mm]	Code
15	1/2" x 20.0	02.150.00.0120
20	3/4" x 25.0	02.150.00.0225
25	1" x 31.8	02.150.00.03318
32	1 1/4" x 38.0	02.150.00.0438
32	1 1/4" x 44.5	02.150.00.04445
40	1 1/2" x 51.0	02.150.00.0551
50	2" x 57.0	02.150.00.0657
50	2" x 63.5	02.150.00.06635
65	2 1/2" x 70	02.220.00.070
65	2 1/2" x 82.5	02.220.00.07825
100	4" x 108	02.220.00.108

**TYPES A and AF** **MALLEABLE CAST IRON COMPRESSION FITTINGS WITH MALE THREAD**  
**FOR PE PIPES** PE 80, PE 100, PE-Xa (each SDR 11) according to DVGW work sheet GW 335 A2/ A3 and DIN 8074/75, DIN EN 12201-2 and DIN 16893

**IT IS NECESSARY TO USE SUPPORT SLEEVES.**

These products are not included in the scope of delivery, so please order them separately. (see page xxx)



**SERIES 153/155:**  
20 mm - 63 mm

**MEDIA:**

water, compressed air, for gas (outside buildings)

**PRESSURE STAGES:**

water (20°C): PE80 and PE-Xa PN 12.5, PE100 PN 16  
 compressed air: PE80 and PE-Xa PN 10, PE100 PN 12.5  
 gas: PE80, PE100 and PE-Xa PN 4

**TESTS/APPROVALS:**

water: DIN 8076/DIN EN 10284, DVGW-Reg.-No.: CW-7511CP0631  
 gas: DVGW work sheet G 5600-1, DVGW Reg.-No.: DG-7521CP0412  
 technical approval national certificates  
 hygienic certificate: national certificates



**SERIES 220:**  
75 mm - 110 mm

**MEDIA:**

water, compressed air

**PRESSURE STAGES:**

water (20°C),  
 compressed air PN 10

DN	Connecting thread x pipe outer-Ø [mm]	Code
15	1/2" x 20	03.153.00.0120
20	3/4" x 25	03.153.00.0225
25	1" x 30 *	03.153.00.0330
25	1" x 32	03.153.00.0332
32	1 1/4" x 38 *	03.153.00.0438
32	1 1/4" x 40	03.153.00.0440
40	1 1/2" x 50	03.153.00.0550
50	2" x 63	03.153.00.0663
65	2 1/2" x 75 *	03.220.00.0775
80	3" x 90 *	03.220.00.0890
100	4" x 110 *	03.220.00.09110

\* - Not for gas applications.

**TYPES A and AF** **MALLEABLE CAST IRON COMPRESSION FITTINGS WITH MALE THREAD**

**DIMENSIONS AND WEIGHTS**

DN	Connecting thread R ISO 7/1	STEEL PIPES		BLACK STEEL PIPES		PE PIPES		Length -A [mm]	Wrench size or flange cover size -sW [mm]	Corner dimension -e [mm]	Depth of insertion [mm]	
		Pipe outer-Ø [mm]	Weight [kg]	Pipe outer-Ø [mm]	Weight [kg]	Pipe outer-Ø [mm]	Weight [kg]				min.	max.
10	3/8"	17.2	0.2					82	31.5	34	25	55
15	1/2"	21.3	0.3	20.0	0.3	20.0	0.3	100	41	44	30	70
20	3/4"	26.9	0.5	25.0	0.5	25.0	0.5	100	50	54	30	70
25	1"	33.7	0.6	31.8	0.6	30.0	0.6	100	55	60	35	65
32	1 1/4"	42.4	1.0	44.5	0.9	38.0	1.0	115	70	76	40	70
						40.0	1.0	115	70	76	40	70
40	1 1/2"	48.3	1.1	51.0	1.1	50.0	1.1	115	75	81	40	75
50	2"	60.3	1.7	57.0	1.6	63.0	1.6	130	90	97	40	85
				63.5	1.6	130	90	97	40	85		
65	2 1/2"	76.1	3.2	70.0	3.3	75.0	3.2	155	100	150	50	95
80	3"	88.9	4.5			90.0	4.5	180	120	160	50	105
100	4"	114.3	6.0	108.0	6.5	110.0	6.0	180	135	185	50	105

COMPRESSION FITTINGS WITH MALE THREAD FOR STEEL PIPES AND BLACK STEEL PIPES

FOR STEEL PIPES 17.2 mm – 60.3 mm

FOR BLACK STEEL PIPES 20 mm – 63.5 mm

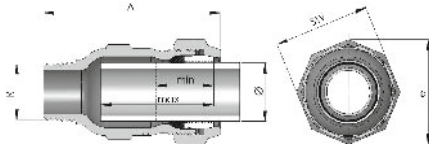

FOR STEEL PIPES 76.1 mm – 114.3 mm

FOR BLACK STEEL PIPES 70 mm – 108 mm

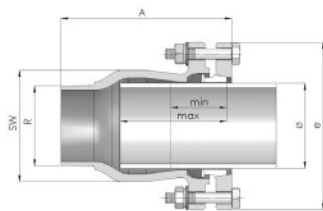

COMPRESSION FITTINGS WITH MALE THREAD FOR PE PIPES WITH REINFORCEMENT SLEEVE

FOR PE PIPES 20 mm – 63 mm

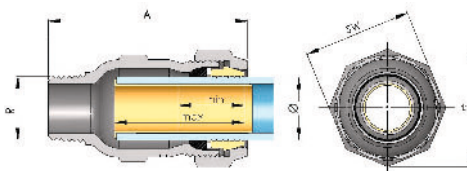

FOR PE PIPES 75 mm – 110 mm

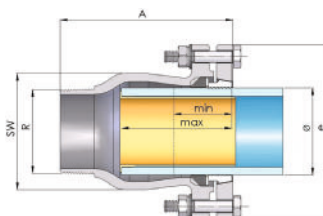

TYPES I and IF

MALLEABLE CAST IRON COMPRESSION FITTINGS WITH FEMALE THREAD

FOR STEEL PIPES

DIN EN 10255 and DIN EN 10220 series 1

**MEDIA:** water, compressed air, heating oil up to 2" (observe regulations for flammable liquids!), for gas (outside buildings)

**TEMPERATURES:** water: up to 25°C, heating water: up to 80°C, heating oil: 40°C; gas: -20°C to +60°C, compressed air: max. 70°C.

**SERIES 150:**  
17.2 mm – 60.3 mm

**PRESSURE STAGES:**

water PN 10 (up to 3/4") or PN 16 (from 1"),  
compressed air PN 12.5, oil PN 6, gas PN 5

**TESTS/APPROVALS:**

water: DVGW W 534, DVGW Reg. No.: DW-8511AU2216;  
fire extinguisher lines: (from size DN25 onwards) - VdS-tested  
heating oil: building approval DIBT, approval no.: Z-38.4-212  
gas: DIN 3387-1, DVGW Reg. No.: NG-4502AP1454  
technical approval: national certificates  
hygienic certificate: national certificates



**SERIES 220:**  
76.1 mm – 114.3 mm

**PRESSURE STAGES:**

water PN 16,  
compressed air PN 10, fire extinguisher lines (VdS) PN 16,  
gas PN 5

**TESTS/APPROVALS:**

water: DVGW W 534, DVGW Reg. No.: DW-8511AU2217;  
fire extinguisher lines: VdS-tested  
gas: DIN 3387-1, DVGW Reg. No.: NG-4502AP1491  
technical approval: national certificates  
hygienic certificate: national certificates



DN	Connecting thread x pipe outer-Ø [mm]	Code
10	3/8" x 17.2	01.150.01.00
15	1/2" x 21.3	01.150.01.01
20	3/4" x 26.9	01.150.01.02
25	1" x 33.7	01.150.01.03
32	1 1/4" x 42.4	01.150.01.04
40	1 1/2" x 48.3	01.150.01.05
50	2" x 60.3	01.150.01.06
65	2 1/2" x 76.1	01.220.01.07
80	3" x 88.9	01.220.01.08
100	4" x 114.3	01.220.01.09

**TYPES I and IF** **MALLEABLE CAST IRON COMPRESSION FITTINGS WITH FEMALE THREAD**  
**FOR BLACK STEEL PIPES** DIN EN 10220 series 2 and 3

**MEDIA:** water, compressed air, heating oil only 57 mm (observe regulations for flammable liquids!)

**TEMPERATURES:** heating water: up to 80°C; oil: 40°C



**SERIES 150:**  
20 mm - 63.5 mm

**PRESSURE STAGES:**

water PN 6,  
compressed air PN 12.5,  
oil PN 6

**TESTS/APPROVALS:**

heating oil: for 57 mm - building approval DIBT, approval no.: Z-38.4-212  
technical approval national certificates



**SERIES 220:**  
70 mm - 108 mm

**PRESSURE STAGES:**

water PN 6,  
compressed air PN 10

DN	Connecting thread x pipe outer-Ø [mm]	Code
15	1/2" x 20.0	02.150.01.0120
20	3/4" x 25.0	02.150.01.0225
25	1" x 31.8	02.150.01.03318
32	1 1/4" x 38.0	02.150.01.0438
32	1 1/4" x 44.5	02.150.01.04445
40	1 1/2" x 51.0	02.150.01.0551
50	2" x 57.0	02.150.01.0657
50	2" x 63.5	02.150.01.06635
65	2 1/2" x 70	02.220.01.70
65	2 1/2" x 82.5	02.220.01.07825
100	4" x 108	02.220.01.108

**TYPES I and IF** **MALLEABLE CAST IRON COMPRESSION FITTINGS WITH FEMALE THREAD**  
**FOR PE PIPES** PE 80, PE 100, PE-Xa (each SDR 11) according to DVGW work sheet GW 335 A2/A3 and DIN 8074/75, DIN EN 12201-2 and DIN 16893

**IT IS NECESSARY TO USE SUPPORT SLEEVES.**

These products are not included in the scope of delivery, so please order them separately. (see page xxx)

**SERIES 153/155:**  
20 mm - 63 mm

**MEDIA:**

Water, compressed air, for gas (outside buildings)

**PRESSURE STAGES:**

water (20°C): PE80 and PE-Xa PN 12.5, PE100 PN 16  
compressed air: PE80 and PE-Xa PN 10, PE100 PN 12.5  
Gas: PE80, PE100 and PE-XA PN 4

**TESTS/APPROVALS:**

water: DIN 8076/DIN EN 10284, DVGW Reg. No.: CW-7511CP0631;  
gas: DVGW work sheet G 5600-1, DVGW Reg. No.: DG-7521CP0412  
technical approval national certificates  
hygienic certificate: national certificates

**SERIES 220:**  
75 mm - 110 mm

**MEDIA:**

water, compressed air

**PRESSURE STAGES:**

water (20°C) PN 10, compressed air PN 10

DN	Connecting thread x pipe outer-Ø [mm]	Code
15	1/2" x 20	03.153.01.0120
20	3/4" x 25	03.153.01.0225
25	1" x 30 *	03.153.01.0330
25	1" x 32	03.153.01.0332
32	1 1/4" x 38*	03.153.01.0438
32	1 1/4" x 40	03.153.01.0440
40	1 1/2" x 50	03.153.01.0550
50	2" x 63	03.153.01.0663
65	2 1/2" x 75*	03.220.01.0775
80	3" x 90*	03.220.01.0890
100	4" x 110*	03.220.01.09110

\* - Not for gas applications.



**TYPES I and IF MALLEABLE CAST IRON COMPRESSION FITTINGS WITH FEMALE THREAD**

**DIMENSIONS AND WEIGHTS**

DN	Connecting thread Rp R 150 7/1	STEEL PIPES		BLACK STEEL PIPES		PE PIPES		Length - A [mm]	Wrench size or flange cover size - SW [mm]	Corner dimension - e [mm]	Depth of insertion [mm]	
		Pipe outer-Ø [mm]	Weight [kg]	Pipe outer-Ø [mm]	Weight [kg]	Pipe outer-Ø [mm]	Weight [kg]				min.	max.
10	3/8"	17.2	0.2					82	31.5	34	25	55
15	1/2"	21.3	0.3	20.0	0.3	20.0	0.3	100	41	44	30	70
20	3/4"	26.9	0.6	25.0	0.5	25.0	0.5	100	50	54	30	70
25	1"	33.7	0.6	31.8	0.6	30.0	0.6	100	55	60	35	65
						32.0	0.6	100	55	60	35	65
32	1 1/4"	42.4	1.0	44.5	0.9	38.0	1.0	115	70	76	40	65
						40.0	1.0	115	70	76	40	70
40	1 1/2"	48.3	1.1	51.0	1.1	50.0	1.1	115	75	81	40	75
50	2"	60.3	1.6	57.0	1.6	63.0	1.6	130	90	97	40	85
						63.5	1.6	130	90	97	40	85
65	2 1/2"	76.1	3.2	70.0	3.4	75.0	3.3	155	100	150	50	95
80	3"	88.9	4.0			90.0	4.5	170	120	160	50	105
100	4"	114.3	5.4	108.0	6.0	110.0	6.1	160	135	185	50	105

**COMPRESSION FITTINGS WITH FEMALE THREAD FOR STEEL PIPES AND BLACK STEEL PIPES**

**FOR STEEL PIPES** 17.2 mm – 60.3 mm

**FOR BLACK STEEL PIPES** 20 mm – 63.5 mm

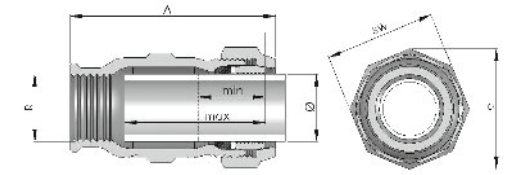

**FOR STEEL PIPES** 76.1 mm – 114.3 mm

**FOR BLACK STEEL PIPES** 70 mm – 108 mm

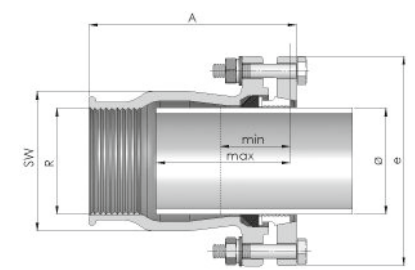

**COMPRESSION WITH FEMALE THREAD FOR PE PIPES WITH REINFORCEMENT SLEEVE**

**FOR PE PIPES** 20 mm – 63 mm

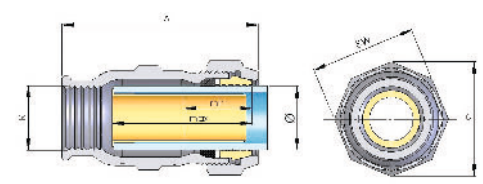

**FOR PE PIPES** 75 mm – 110 mm

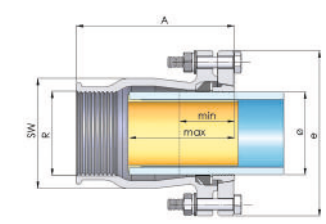

**TYPES O and OF** **MALLEABLE CAST IRON COMPRESSION FITTINGS , CLAMPING ON BOTH SIDES**

**FOR STEEL PIPES** DIN EN 10255 and DIN EN 10220 series 1

**MEDIA:** water, compressed air, heating oil up to 2" (observe the regulations for flammable liquids!), for gas (outside buildings)

**OPERATING TEMPERATURE:** water: up to 25°C, heating water: up to 80°C, heating oil: 40°C; gas: -20°C to +60°C, compressed air: max. 70°C.



**SERIES 150:**  
17.2 mm - 60.3 mm

**PRESSURE STAGES:**  
water PN 10 (up to 3/4") or PN 16 (from 1"),  
compressed air PN 12.5, oil PN 6, gas PN 5, fire extinguisher lines (VdS) PN 12.5

**TESTS/APPROVALS:**  
water: DVGW W 534, DVGW Reg. No.: DW-8511AU2216;  
fire extinguisher lines: (from size DN25 onwards) - VdS-tested  
heating oil: building approval DIBT, approval no.: Z-38.4-212  
gas: DIN 3387-1, DVGW Reg. No.: NG-4502AP1454  
technical approval national certificates  
hygienic certificate: national certificates



**SERIES 220:**  
76.1 mm - 114.3 mm

**PRESSURE STAGES:**  
water PN 16,  
compressed air PN 10, fire extinguisher lines (VdS) PN 16,  
gas PN 5

**TESTS/APPROVALS:**  
water: DVGW W 534, DVGW Reg. No.: DW-8511AU2217;  
fire extinguisher lines: VdS-tested  
gas: DIN 3387-1, DVGW Reg. No.: NG-4502AP1491  
technical approval national certificates  
hygienic certificate: national certificates

DN	Pipe outer -Ø [mm]	Code
10	17.2 x 17.2 (3/8")	01.150.02.00
15	21.3 x 21.3 (1/2")	01.150.02.01
20	26.9 x 26.9 (3/4")	01.150.02.02
25	33.7 x 33.7 (1")	01.150.02.03
32	42.4 x 42.4 (1 1/4")	01.150.02.04
40	48.3 x 48.3 (1 1/2")	01.150.02.05
50	60.3 x 60.3 (2")	01.150.02.06
65	76.1 x 76.1 (2 1/2")	01.220.02.07
80	88.9 x 88.9 (3")	01.220.02.08
100	114.3 x 114.3 (4")	01.220.02.09

**TYPES O and OF** **MALLEABLE CAST IRON COMPRESSION FITTINGS, CLAMPING ON BOTH SIDES**

**FOR BLACK STEEL PIPES** DIN EN 10220 series 2 and 3

**MEDIA:** water, compressed air, heating oil only 57 mm (observe regulations for flammable liquids!)

**TEMPERATURES:** heating water: up to 80°C; oil: 40°C

**SERIES 150:**  
20 mm - 63.5 mm

**PRESSURE STAGES:**  
water PN 6,  
compressed air PN 12.5,  
oil PN 6

**TESTS/APPROVALS:**  
heating oil: for 57 mm - building approval DIBT, approval no.: Z-38.4-212  
technical approval national certificates

**SERIES 220:**  
70 mm - 108 mm

**PRESSURE STAGES:**  
water PN 6,  
compressed air PN 10  
technical approval national certificates

DN	Pipe outer-Ø [mm]	Code
15	20.0 x 20.0	02.150.02.20
20	25.0 x 25.0	02.150.02.25
25	31.8 x 31.8	02.150.02.318
32	38.0 x 38.0	02.150.02.38
32	44.5 x 44.5	02.150.02.445
40	51.0 x 51.0	02.150.02.51
50	57.0 x 57.0	02.150.02.57
50	63.5 x 63.5	02.150.02.635
65	70.0 x 70.0	02.220.02.70
100	108.0 x 108.0	02.220.02.108





**TYPES O and OF** **MALLEABLE CAST IRON COMPRESSION FITTINGS , CLAMPING ON BOTH SIDES**

**FOR PE PIPES** PE 80, PE 100, PE-Xa (each SDR 11) according to DVGW work sheet GW 335 A2/ A3 and DIN 8074/75, DIN EN 12201-2 and DIN 16893

**IT IS NECESSARY TO USE SUPPORT SLEEVES.**

These products are not included in the scope of delivery, so please order them separately. (see page xxx)



**SERIES 153/155:**  
20 mm – 63 mm

**MEDIA:**  
Water, compressed air, for gas (outside buildings)

**PRESSURE STAGES:**  
water (20°C): PE80 and PE-Xa PN 12.5, PE100 PN 16  
compressed air: PE80 and PE-Xa PN 10, PE100 PN 12.5  
gas: PE100 PN 10, PE80 PN4, PE-Xa PN 8

**TESTS/APPROVALS:**  
water: DIN 8076/DIN EN 10284, DVGW Reg. No.: CW-7511CP0631;  
gas: DVGW work sheet G 5600-1, DVGW Reg. No.: DG-7521CP0412  
technical approval national certificates  
hygienic certificate: national certificates



**SERIES 220:**  
75 mm – 110 mm

**MEDIA:** water, compressed air,  
**PRESSURE STAGES:** water (20°C), compressed air PN 10

DN	Pipe outer-Ø [mm]	Code
<b>Steel pipe x PE pipe Ø [mm]</b>		
15	21.3 x 20	03.154.02.0120
20	26.9 x 25	03.154.02.0225
25	33.7 x 32	03.154.02.0332
32	42.4 x 38*	03.154.02.0438
32	42.4 x 40	03.154.02.0440
40	48.3 x 50	03.154.02.0550
50	60.3 x 63	03.154.02.0663
65	76.1 x 75*	03.220.02.0775
80	88.9 x 90*	03.220.02.0890
100	114.3 x 110*	03.220.02.09110
<b>PE-PE pipe [mm]</b>		
15	20 x 20	03.155.02.20
20	25 x 25	03.155.02.25
25	30 x 30*	03.155.02.30
25	32 x 32	03.155.02.32
32	38 x 38*	03.155.02.38
32	40 x 40	03.155.02.40
40	50 x 50	03.155.02.50
50	63 x 63	03.155.02.63
65	75 x 75*	03.220.02.75
80	90 x 90*	03.220.02.90
100	110 x 110*	03.220.02.110

\* - Not for gas applications.

**TYPES O and OF** **MALLEABLE CAST IRON COMPRESSION FITTINGS , CLAMPING ON BOTH SIDES**

**DIMENSIONS AND WEIGHTS**

DN	STEEL PIPES		BLACK STEEL PIPES		PE PIPES		Length -A [mm]	Wrench size or flange cover size - SW [mm]	Corner dimension -e [mm]	Depth of insertion [mm]	
	Pipe outer-Ø [mm]	Weight [kg]	Pipe outer-Ø [mm]	Weight [kg]	Pipe outer-Ø [mm]	Weight [kg]				min.	max.
10	17.2	0.2					85	31.5	34	25	35
15	21.3	0.4	20.0	0.5	20.0	0.5	120	41	44	30	50
20	26.9	0.7	25.0	0.7	25.0	0.7	120	50	54	30	50
25	33.7	0.8	31.8	0.8	32.0	0.8	120	55	60	35	50
32	42.4	1.3	44.5	1.1	40.0	1.3	130	70	76	40	55
40	48.3	1.5	51.0	1.3	50.0	1.5	130	75	81	40	55
50	60.3	2.2	57.0	2.4	63.0	2.2	145	90	97	40	65
			63.5	2.3			145	90	97	40	65
65	76.1	5.1	70.0	5.5	75.0	5.1	200	100	150	50	75
80	88.9	6.8			90.0	6.0	215	120	160	50	85
100	114.3	7.6	108.0	7.7	110.0	7.6	205	135	185	50	85

COMPRESSION FITTINGS CLAMPING ON BOTH SIDES FOR STEEL PIPES AND BLACK STEEL PIPES

FOR STEEL PIPES 17.2 mm – 60.3 mm

FOR BLACK STEEL PIPES 20 mm – 63.5 mm

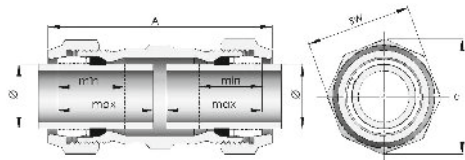

FOR STEEL PIPES 76.1 mm – 114.3 mm

FOR BLACK STEEL PIPES 70 mm – 108 mm

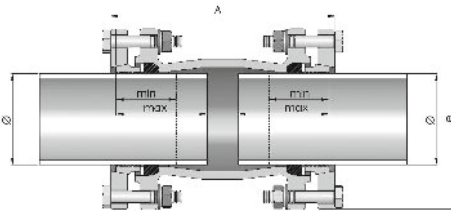

COMPRESSION FITTINGS CLAMPING ON BOTH SIDES FOR PE PIPES WITH REINFORCEMENT SLEEVE

FOR PE PIPES 20 mm – 63 mm

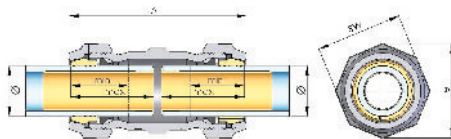

FOR PE PIPES 75 mm – 110 mm

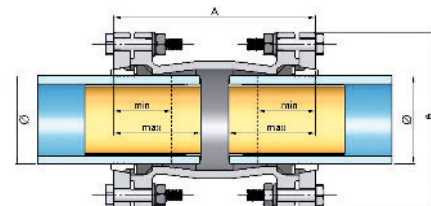

TYPES T and TF

MALLEABLE CAST IRON COMPRESSION FITTINGS, CLAMPING ON BOTH SIDES OUTLET WITH FEMALE THREAD

FOR STEEL PIPES DIN EN 10255 and DIN EN 10220 series 1

**MEDIA:** water, compressed air, heating oil up to 2" (observe regulations for flammable liquids!), for gas (outside buildings)

**TEMPERATURES:** water: up to 25°C, heating water: up to 80°C, heating oil: 40°C; gas: -20°C to +60°C, compressed air: max. 70°C.

**SERIES 150:**  
17.2 mm – 60.3 mm

**PRESSURE STAGES:**

water PN 10 (up to 3/4") or PN 16 (from 1"),  
compressed air PN 12.5, oil PN 6, gas PN 5

**TESTS/APPROVALS:**

water: DVGW W 534, DVGW Reg. No: DW-8511AU2216  
heating oil: building approval DIBT, approval no.: Z-38.4-212  
gas: DIN 3387-1, DVGW Reg. No.: NG-4502AP1454  
technical approval national certificates  
hygienic certificate: national certificates



**SERIES 220:**  
76.1 mm – 114.3 mm

**PRESSURE STAGES:**

water PN 16,  
compressed air PN 10,  
gas PN 5

**TESTS/APPROVALS:**

water: DVGW W 534, DVGW Reg. No.: DW-8511AU2217;  
gas: DIN 3387-1, DVGW Reg. No.: NG-4502AP1491  
technical approval national certificates  
hygienic certificate: national certificates



DN	Pipe outer- $\phi$ x connecting thread, 1 x 2 x 3	Code
10	17.2 x 1 7.2 x 3/8"	01.150.04.00
15	21.3 x 21.3 x 1/2"	01.150.04.01
20	26.9 x 26.9 x 3/4"	01.150.04.02
25	33.7 x 33.7 x 1"	01.150.04.03
32	42.4 x 42.4 x 1 1/4"	01.150.04.04
40	48.3 x 48.3 x 1 1/2"	01.150.04.05
50	60.3 x 60.3 x 2"	01.150.04.06
65	76.1 x 76.1 x 2 1/2"	01.220.04.07
80	88.9 x 88.9 x 3"	01.220.04.08
100	114.3 x 114.3 x 4"	01.220.04.09

**TYPES T and TF** **MALLEABLE CAST IRON COMPRESSION FITTINGS, CLAMPING ON BOTH SIDES OUTLET WITH FEMALE THREAD**

**FOR BLACK STEEL PIPES** DIN EN 10220 series 2 and 3

**MEDIA:** water, compressed air, heating oil only 57 mm (observe regulations for flammable liquids!)

**TEMPERATURES:** heating water: up to 80°C; oil: 40°C



**SERIES 150:**  
20 mm - 63.5 mm

**PRESSURE STAGES:**

water PN 6,  
compressed air PN 12.5,  
oil PN 6

**TESTS/APPROVALS:**

heating oil: for 57 mm - building approval DIBT, approval no.: Z-38.4-212  
technical approval national certificates

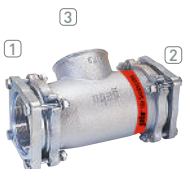

**SERIES 220:**  
70 mm - 108 mm

**PRESSURE STAGES:**

water PN 6,  
compressed air PN 10

DN	Pipe outer-Ø x connecting thread, 1 x 2 x 3	Code
15	20.0 x 20.0 x 1/2"	02.150.04.20
20	25.0 x 25.0 x 3/4"	02.150.04.25
25	31.8 x 31.8 x 1"	02.150.04.318
32	38.0 x 38.0 x 1 1/4"	02.150.04.38
32	44.5 x 44.5 x 1 1/4"	02.150.04.445
40	51.0 x 51.0 x 1 1/2"	02.150.04.51
50	57.0 x 57.0 x 2"	02.150.04.57
50	63.5 x 63.5 x 2"	02.150.04.635
65	70.0 x 70.0 x 2 1/2"	02.220.04.70
100	108.0 x 108.0 x 4	02.220.04.108

**TYPES T and TF** **MALLEABLE CAST IRON COMPRESSION FITTINGS, CLAMPING ON BOTH SIDES OUTLET WITH FEMALE THREAD**

**FOR PE PIPES** PE 80, PE 100, PE-Xa (each SDR 11) according to DVGW work sheet GW 335 A2/A3 and DIN 8074/75, DIN EN 12201-2 and DIN 16893

**IT IS NECESSARY TO USE SUPPORT SLEEVES.**

These products are not included in the scope of delivery, so please order them separately. (see page xxx)

**SERIES 153/155:**  
20 mm - 63 mm

**MEDIA:**

water, compressed air, for gas (outside buildings)

**PRESSURE STAGES:**

water (20°C): PE80 and PE-Xa PN 12.5, PE100 PN 16  
compressed air: PE80 and PE-Xa PN 10, PE100 PN 12.5  
gas: PE80, PE100 and PF4

**TESTS/APPROVALS:**

water: DIN 8076/DIN EN 10284, DVGW Reg. No.: CW-7511CP0631;  
gas: DVGW work sheet G 5600-1, DVGW Reg. No.: DG-7521CP0412  
technical approval national certificates  
hygienic certificate: national certificates



**SERIES 220:**  
75 mm - 110 mm

**MEDIA:**

water, compressed air,

**PRESSURE STAGES:**

water (20°C), compressed air PN 10



DN	Pipe outer-Ø x connecting thread, 1 x 2 x 3	Code
<b>Steel pipe x PE pipe Ø [mm]</b>		
15	21.3 x 20 x 1/2"	03.154.04.0120
20	26.9 x 25 x 3/4"	03.154.04.0225
25	33.7 x 32 x 1"	03.154.04.0332
32	42.4 x 38 x 1 1/4"	03.154.04.0438
32	42.4 x 40 x 1 1/4"	03.154.04.0440
40	48.3 x 50 x 1 1/2"	03.154.04.0550
50	60.3 x 63 x 2"	03.154.04.0663
65	76.1 x 75 x 2 1/2"	03.220.04.0775
80	88.9 x 90 x 3"	03.220.04.0890
100	114.3 x 110 x 4"	03.220.04.09110
<b>PE-PE pipe [mm]</b>		
15	20 x 20 x 1/2"	03.155.04.20
20	25 x 25 x 3/4"	03.155.04.25
25	30 x 30 x 1" *	03.155.04.30
25	32 x 32 x 1"	03.155.04.32
32	38 x 38 x 1 1/4"	03.155.04.38
32	40 x 40 x 1 1/4"	03.155.04.40
40	50 x 50 x 1 1/2"	03.155.04.50
50	63 x 63 x 2"	03.155.04.63
65	75 x 75 x 2 1/2"	03.220.04.75
80	90 x 90 x 3"	03.220.04.90
100	110 x 110 x 4"	03.220.04.110

\* - Not for gas applications.

**TYPES T and TF** MALLEABLE CAST IRON COMPRESSION FITTINGS, CLAMPING ON BOTH SIDES / OUTLET WITH FEMALE THREAD

**DIMENSIONS AND WEIGHTS**

DN	Connecting thread Rp ISO 7/1	STEEL PIPES		BLACK STEEL PIPES		PE PIPES		Length -A [mm]	Wrench size or flange cover size - SW [mm]	Dormer dimension -e [mm]	Depth of insertion [mm]	
		Pipe outer-φ [mm]	weight [kg]	Pipe outer-φ [mm]	weight [kg]	Pipe outer-φ [mm]	weight [kg]				min.	max.
10	3/8"	17.2	0.3					95	31.5	34	25	35
15	1/2"	21.3	0.5	20.0	0.5	20	0.5	120	41	44	30	40
20	3/4"	26.9	0.8	25.0	0.8	25	0.8	130	50	54	30	40
25	1"	33.7	0.9	31.8	0.9	30	0.9	135	55	60	35	42
						32	0.9	135	55	60	35	42
32	1 1/4"	42.4	1.4	44.5	1.4	38	1.5	140	70	76	40	45
						40	1.5	140	70	76	40	45
40	1 1/2"	48.3	1.6	51.0	1.6	50	1.6	155	75	81	40	45
50	2"			57.0	2.5			180	90	97	40	45
		60.3	2.5	63.5	2.7	63	2.5	180	90	97	40	55
65	2 1/2"	76.1	6.0	70.0	6.4	75	5.5	250	./.	150	50	75
80	3"	88.9	6.8			90	7.5	280	./.	160	50	85
100	4"	114.3	9.1	108.0	9.3	110	9.1	280	./.	185 (180 for PE)	50	85

**COMPRESSION FITTINGS CLAMPING ON BOTH SIDES OUTLET WITH FEMALE THREAD FOR STEEL PIPES AND BLACK STEEL PIPES**

**FOR STEEL PIPES** 17.2 mm – 60.3 mm

**FOR BLACK STEEL PIPES** 20 mm – 63.5 mm

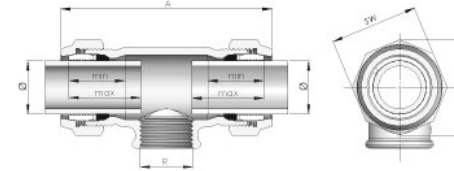

**FOR STEEL PIPES** 76.1 mm – 114.3 mm

**FOR BLACK STEEL PIPES** 70 mm – 108 mm

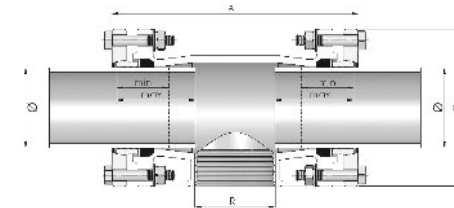

**COMPRESSION FITTINGS CLAMPING ON BOTH SIDES OUTLET WITH FEMALE THREAD FOR PE PIPES WITH REINFORCEMENT SLEEVE**

**FOR PE PIPES** 20 mm – 63 mm

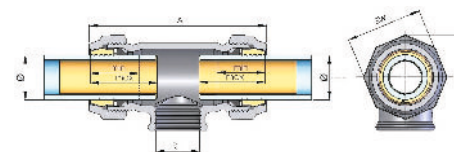

**FOR PE PIPES** 75 mm – 110 mm

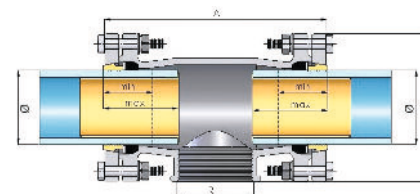

<b>TYPE OR</b>	<b>MALLEABLE CAST IRON COMPRESSION FITTINGS CLAMPING ON BOTH SIDES, REDUCED</b>
<b>FOR STEEL PIPES</b>	DIN EN 10255 and DIN EN 10220 series 1

**MEDIA:** water, compressed air, heating oil (observe regulations for flammable liquids!), for gas (outside buildings)

**OPERATING TEMPERATURE:** water: up to 25°C, heating water: up to 80°C, heating oil: 40°C; gas: -20°C to +60°C, compressed air: max. 70°C.



**SERIES 150**  
33.7 mm - 60.3 mm

**PRESSURE STAGES:**

water PN 10 (up to 3/4") or PN 16 (from 1"),  
compressed air PN 12.5, oil PN 6, VdS PN 12.5, gas PN 5

**TESTS/APPROVALS:**

water: DVGW W 534, DVGW Reg. No.: DW-8511AU2216;  
heating oil: building approval DIBT, approval no.: Z-38.4-212  
fire extinguisher lines: (from size DN25 onwards) - VdS-tested  
gas: DIN 3387-1, DVGW Reg. No.: NG-4502AP1454  
technical approval national certificates  
hygienic certificate: national certificates

DN	Pipe outer-Ø [mm]	Code
25 x 20	33.7 x 26.9 (1" x 3/4")	01.150.02.0302
32 x 20	42.4 x 26.9 (1 1/4" x 3/4")	01.150.02.0402
32 x 25	42.4 x 33.7 (1 1/4" x 1")	01.150.02.0403
40 x 25	48.3 x 33.7 (1 1/2" x 1")	01.150.02.0503
40 x 32	48.3 x 42.4 (1 1/2" x 1 1/4")	01.150.02.0504
50 x 32	60.3 x 42.4 (2" x 1 1/4")	01.150.02.0604
50 x 40	60.3 x 48.3 (2" x 1 1/2")	01.150.02.0605

<b>TYPE OR</b>	<b>MALLEABLE CAST IRON COMPRESSION FITTINGS CLAMPING ON BOTH SIDES, REDUCED</b>
<b>FOR BLACK STEEL PIPES</b>	DIN EN 10220 series 2 and 3

**MEDIA:** water, compressed air, heating oil only 57 mm (observe regulations for flammable liquids!)

**TEMPERATURE:** heating water: up to 80°C; oil: 40°C



**SERIES 150:**  
20 mm - 63.5 mm

**PRESSURE STAGES:**

water PN 6, compressed air PN 12.5, oil PN 6

**TESTS/APPROVALS:**

Heating oil: for 57 mm - Building approval DIBT, approval no.: Z-38.4-212  
Technical Approval national certificates

Product on request.

<b>TYPE OR</b>	<b>MALLEABLE CAST IRON COMPRESSION FITTINGS CLAMPING ON BOTH SIDES, REDUCED</b>
<b>FOR PE PIPES</b>	PE 80, PE 100, PE-Xa (each SDR 11) according to DVGW work sheet GW 335 A2/A3 and DIN 8074/75, DIN EN 12201-2 and DIN 16893

**IT IS NECESSARY TO USE SUPPORT SLEEVES.**

These products are not included in the scope of delivery, so please order them separately. (see page xxx)

**SERIES 153/155:**  
32 mm - 63 mm

**MEDIA:**

Water, compressed air, for gas (outside buildings)

**PRESSURE STAGES:**

water [20°C]: PE80 and PE-Xa PN 12.5, PE100 PN 16  
compressed air: PE80 and PE-Xa PN 10, PE100 PN 12.5  
gas: PE100 PN 10, PE80 PN 4, PE-Xa PN 8;

**TESTS/APPROVALS:**

water: DIN 8076/DIN EN 10284, DVGW: CW-7511CP0631;  
gas: DVGW work sheet 5600-1, DVGW Reg. No.: DG-7521CP0412  
technical approval national certificates  
hygienic certificate: national certificates



DN	Pipe outer -Ø [mm]	Code
<b>Steel pipe x PE pipe Ø [mm]</b>		
20 x 25	26.9 x 32	03.154.02.0232
20 x 32	26.9 x 40	03.154.02.0240
25 x 20	33.7 x 25	03.154.02.0325
25 x 32	33.7 x 40	03.154.02.0340
25 x 40	33.7 x 50	03.154.02.0350
32 x 20	42.4 x 25	03.154.02.0425
32 x 25	42.4 x 32	03.154.02.0432
32 x 40	42.4 x 50	03.154.02.0450
32 x 50	42.4 x 63	03.154.02.0463
40 x 25	48.3 x 32	03.154.02.0532
40 x 32	48.3 x 40	03.154.02.0540
40 x 50	48.3 x 63	03.154.02.0563
50 x 32	60.3 x 40	03.154.02.0640
50 x 40	60.3 x 50	03.154.02.0650
<b>PE-PE pipe [mm]</b>		
20 x 25	25 x 32	03.155.02.2532
20 x 32	25 x 40	03.155.02.2540
25 x 32	32 x 40	03.155.02.3240
25 x 40	32 x 50	03.155.02.3250
32 x 40	40 x 50	03.155.02.4050
32 x 50	40 x 63	03.155.02.4063
40 x 50	50 x 63	03.155.02.5063

**TYPE OR** MALLEABLE CAST IRON COMPRESSION FITTINGS CLAMPING ON BOTH SIDES, REDUCED

**DIMENSIONS AND WEIGHTS**

DN	STEEL PIPES	BLACK STEEL PIPES	STEEL/BLACK STEEL	PE PIPES	PE PIPES	Length -A [mm]	Wrench size -SW [mm]	Corner dimension -e [mm]	Depth of insertion [mm]		
	Pipe outer-Ø [mm]	Pipe outer-Ø [mm]	Weight [kg]	Pipe outer-Ø [mm]	Weight [kg]				min.1	min.2	max.
25 x 20	33.7 x 26.9	31.8 x 25.0	0,8	32 x 25	0,7	117	55	60	35	30	50
32 x 20	42.4 x 26.9	44.5 x 25.0	1,0	38 x 25	1,0	130	70	76	40	30	55
				40 x 25	1,0						
32 x 25	42.4 x 33.7	44.5 x 31.8	1,1	32 x 38	1,1	130	70	76	40	35	55
				40 x 32	1,1						
40 x 25	48.3 x 33.7	51.0 x 31.8	1,3	50 x 30	1,3	130	75	81	40	35	55
				50 x 32	1,3						
40 x 32	48.3 x 42.4	51.0 x 44.5	1,3	50 x 38	1,3	130	75	81	40	40	55
				50 x 40	1,3						
50 x 32	60.3 x 42.4	57.0 x 44.5	2,0	63 x 38	2,1	145	90	97	40	40	65
				63 x 40	2,0						
50 x 40	60.3 x 48.3	57.0 x 51.0	2,2	63 x 50	2,2	145	90	97	40	40	65

**COMPRESSION FITTINGS CLAMPING ON BOTH SIDES, REDUCED FOR STEEL PIPES AND BLACK STEEL PIPES**

STEEL PIPES	33.7 mm – 60.3 mm
BLACK STEEL PIPES	20 mm – 63.5 mm

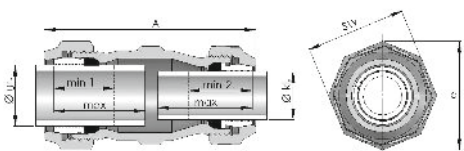

**COMPRESSION FITTINGS CLAMPING ON BOTH SIDES, REDUCED FOR PE PIPES WITH REINFORCEMENT SLEEVE**

PE PIPES	32 mm – 63 mm
----------	---------------

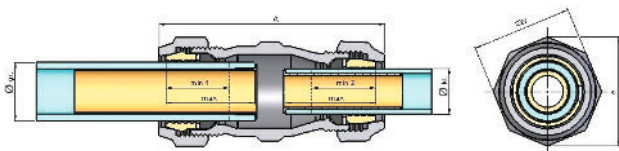

**TYPE OL** MALLEABLE CAST IRON COMPRESSION FITTINGS CLAMPING ON BOTH SIDES, LONG VERSION

FOR STEEL PIPES DIN EN 10255 and DIN EN 10220 series 1

**MEDIA:** water, compressed air, heating oil (observe regulations for flammable liquids!), for gas (outside buildings)

**TEMPERATURES:** water: up to 25°C, heating water: up to 80°C, heating oil: 40°C; gas: -20°C to +60°C, compressed air: max. 70°C.

**SERIES 150:**  
21.3 mm – 60.3 mm

**PRESSURE STAGES:**  
water PN 10 (up to 3/4") or PN 16 (from 1"),  
compressed air PN 12.5, oil PN 6, fire extinguisher lines (VdS) PN 12.5,  
gas PN 5

**TESTS/APPROVALS:**  
water: DVGW W 534, DVGW Reg. No: DW-8511AU2216  
heating oil: Building approval DIBT, approval no.: Z-38.4-212  
VdS-tested (fire extinguisher lines) from size DN25 onwards  
gas: DIN 3387-1, DVGW Reg. No.: NG-4502AP1454  
technical approval national certificates  
hygienic certificate: national certificates



DN	Pipe outer-Ø [mm]	Code
15	21.3 x 21.3 (1/2")	<b>01.150.03.01</b>
20	26.9 x 26.9 (3/4")	<b>01.150.03.02</b>
25	33.7 x 33.7 (1")	<b>01.150.03.03</b>
32	42.4 x 42.4 (1 1/4")	<b>01.150.03.04</b>
40	48.3 x 48.3 (1 1/2")	<b>01.150.03.05</b>
50	60.3 x 60.3 (2")	<b>01.150.03.06</b>

**TYPE OL** MALLEABLE CAST IRON COMPRESSION FITTINGS, CLAMPING ON BOTH SIDES, LONG VERSION

FOR BLACK STEEL PIPES DIN EN 10220 series 2 and 3

**MEDIA:** water, compressed air, heating oil only 57 mm (observe regulations for flammable liquids!)

**TEMPERATURES:** heating water: up to 80°C; oil: 40°C

**SERIES 150:**  
20 mm – 63.5 mm

**PRESSURE STAGES:**  
water PN 6,  
compressed air PN 12.5,  
oil PN 6

**TESTS/APPROVALS:**  
heating oil: for 57 mm - building approval DIBT, approval no.: Z-38.4-212  
technical approval national certificates



Product on request.

**TYPE 0L** MALLEABLE CAST IRON FITTINGS, CLAMPING ON BOTH SIDES, LONG VERSION

**FOR PE PIPES** PE 80, PE 100, PE-Xa (each SDR 11) according to DVGW work sheet GW 335 A2/ A3 and DIN 8074/75, DIN EN 12201-2 and DIN 16893

**IT IS NECESSARY TO USE SUPPORT SLEEVES.**

These products are not included in the scope of delivery, so please order them separately. (see page xxx)



**SERIES 153/155:**  
20 mm – 63 mm

**MEDIA:**

Water, compressed air, for gas (outside buildings)

**PRESSURE STAGES:**

water (20°C): PE80 and PE-Xa PN 12.5, PE100 PN 16  
compressed air: PE80 and PE-Xa PN 10, PE100 PN 12.5  
gas: PE100 PN10, PE80 PN 4, PE-Xa PN 8;

**TESTS/APPROVALS:**

water: DIN 8076/DIN EN 10284, DVGW: CW-7511CP0631;  
gas: DVGW work sheet G 5600-1, DVGW Reg. No.: DG-7521CP0412  
technical approval national certificates  
hygienic certificate: national certificates

DN	Pipe outer-Ø [mm]	Code
<b>Steel pipe x PE pipe Ø [mm]</b>		
15	21.3 x 20	03.154.03.0120
20	26.9 x 25	03.154.03.0225
25	33.7 x 32	03.154.03.0332
32	42.4 x 40	03.154.03.0440
40	48.3 x 50	03.154.03.0550
50	60.3 x 63	03.154.03.0663
<b>PE-PE pipe [mm]</b>		
15	20 x 20	03.155.03.20
20	25 x 25	03.155.03.25
25	32 x 32	03.155.03.32
32	40 x 40	03.155.03.40
40	50 x 50	03.155.03.50
50	63 x 63	03.155.03.63

**TYPE 0L** MALLEABLE CAST IRON COMPRESSION FITTINGS, CLAMPING ON BOTH SIDES, LONG VERSION

**DIMENSIONS AND WEIGHTS**

DN	STEEL PIPES		BLACK STEEL PIPES		PE PIPES		Length ~A [mm]	Wrench size ~SW [mm]	Corner dimension ~e [mm]	Depth of insertion [mm]			
	Pipe outer-Ø [mm]	Weight [kg]	Pipe outer-Ø [mm]	Weight [kg]	Pipe outer-Ø [mm]	Weight [kg]				STEEL		PE	
										BLACK			
										min.	max.	min.	max.
15	21.3	0.8	20.0	0.8	20	0.9	230	41	44	30	100	30	50
20	26.9	1.2	25.0	1.3	25	1.4	230	50	54	30	100	30	60
25	33.7	1.5	31.8	1.4	30	1.5	230	55	60	35	100	35	60
					32	1.5	230	55	60		35	60	
32	42.4	1.7			38	2.1	230	70	76	40	100	40	70
			44.5	1.8	40	1.7	230	70	76	40	100	40	70
40	48.3	2.0	51.0	2.5	50	2.0	230	75	81	40	100	40	70
50	60.3	3.2	57.0	3.3	63	3.3	230	90	97	40	100	40	80
			63.5	3.3			230	90	97	40	100	40	80

**COMPRESSION FITTINGS CLAMPING ON BOTH SIDES, LONG VERSION FOR STEEL PIPES AND BLACK STEEL PIPES**

**FOR STEEL PIPES** 21.3 mm – 60.3 mm  
**FOR BLACK STEEL PIPES** 20 mm – 63.5 mm

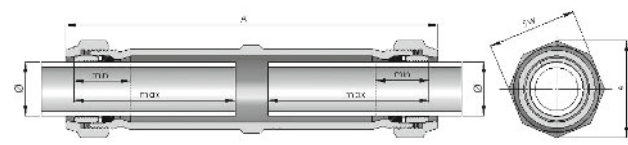

**COMPRESSION FITTINGS CLAMPING ON BOTH SIDES, LONG VERSION FOR PE PIPES WITH REINFORCEMENT SLEEVE**

**FOR PE PIPES** 20 mm – 63 mm

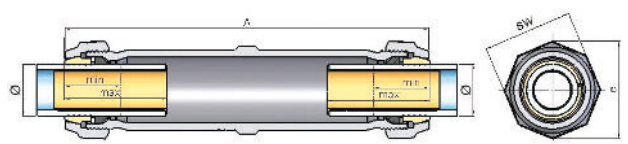



**TYPE WO** MALLEABLE CAST IRON COMPRESSION FITTINGS ELBOW, CLAMPING ON BOTH SIDES

**FOR STEEL PIPES** DIN EN 10255 and DIN EN 10220 series 1

**MEDIA:** water, compressed air, heating oil (observe regulations for flammable liquids!), for gas (outside buildings)

**OPERATING TEMPERATURE:** water: up to 25°C, heating water: up to 80°C, heating oil: 40°C; gas: -20°C to +60°C, compressed air: max. 70°C.



**SERIES 150**  
21.3 mm - 60.3 mm

**PRESSURE STAGES:**  
water PN 10 (up to 3/4") or PN 16 (from 1"), compressed air PN 12.5, oil PN 6, gas PN 5

**TESTS/APPROVALS:**  
water: DVGW W 534, DVGW Reg. No: DW-8511AU2216  
heating oil: building approval DIBT, approval no.: Z-38.4-212  
gas: DIN 3387-1, DVGW Reg. No.: NG-4502AP1454  
technical approval national certificates  
hygienic certificate: national certificates

DN	Pipe outer-Ø [mm]	Code
15	21.3 x 21.3 1/2"	01.150.08.01
20	26.9 x 26.9 (3/4")	01.150.08.02
25	33.7 x 33.7 (1")	01.150.08.03
32	42.4 x 42.4 (1 1/4")	01.150.08.04
40	48.3 x 48.3 (1 1/2")	01.150.08.05
50	60.3 x 60.3 (2")	01.150.08.06

**TYPE WO** MALLEABLE CAST IRON COMPRESSION FITTINGS ELBOW, CLAMPING ON BOTH SIDES

**FOR BLACK STEEL PIPES** DIN EN 10220 series 2 and 3

**MEDIA:** water, compressed air, heating oil only 57 mm (observe regulations for flammable liquids!)

**TEMPERATURES:** heating water: up to 80°C; oil: 40°C



**SERIES 150:**  
20 mm - 63.5 mm

**PRESSURE STAGES:**  
water PN 6, compressed air PN 12.5, oil PN 6

**TESTS/APPROVALS:**  
heating oil: for 57 mm - building approval DIBT, approval no.: Z-38.4-212  
technical approval national certificates

Product on request.

**TYPE WO** MALLEABLE CAST IRON COMPRESSION FITTINGS ELBOW, CLAMPING ON BOTH SIDES

**FOR PE PIPES** PE 80, PE 100, PE-Xa (each SDR 11) according to DVGW work sheet GW 335 A2/A3 and DIN 8074/75, DIN EN 12201-2 and DIN 16893

**IT IS NECESSARY TO USE SUPPORT SLEEVES.**

These products are not included in the scope of delivery, so please order them separately. (see page xxx)

**SERIES 153/155:**  
20 mm - 63 mm

**MEDIA:**  
Water, compressed air, for gas (outside buildings)

**PRESSURE STAGES:**  
water (20°C): PE80 and PE-Xa PN 12.5, PE100 PN 16  
compressed air: PE80 and PE-Xa PN 10, PE100 PN 12.5  
gas: PE80 PN 4, PE-Xa PN 8; PE100 PN 10

**TESTS/APPROVALS:**  
water: DIN 8076/DIN EN 10284, DVGW: CW-7511CP0631;  
gas: DVGW work sheet G 5600-1, DVGW Reg. No.: DG-7521CP0412  
technical approval national certificates  
hygienic certificate: national certificates



DN	Pipe outer-Ø [mm]	Code
<b>Steel pipe x PE pipe-Ø [mm]</b>		
15	21.3 x 20	03.154.08.0120
20	26.9 x 25	03.154.08.0225
25	33.7 x 32	03.154.08.0332
32	42.4 x 40	03.154.08.0440
40	48.3 x 50	03.154.08.0550
50	60.3 x 63	03.154.08.0663
<b>PE-PE pipe [mm]</b>		
15	20 x 20	03.155.08.20
20	25 x 25	03.155.08.25
25	32 x 32	03.155.08.32
32	40 x 40	03.155.08.40
40	50 x 50	03.155.08.50
50	63 x 63	03.155.08.63



**TYPE W0** MALLEABLE CAST IRON COMPRESSION FITTINGS ELBOW, CLAMPING ON BOTH SIDES

**DIMENSIONS AND WEIGHTS**

DN	STEEL PIPES		BLACK STEEL PIPES		PE PIPES		Length -A [mm]	Wrench size -SW [mm]	Corner dimension -e [mm]	Depth of insertion [mm]	
	Pipe outer-Ø [mm]	Weight [kg]	Pipe outer-Ø [mm]	Weight [kg]	Pipe outer-Ø [mm]	Weight [kg]				min.	max.
15	21.3	0.5	20.0	0.8	20	0.5	100	41	44	30	50
20	26.9	0.7	25.0	0.7	25	0.7	105	50	54	30	50
25	33.7	1.0	31.8	1.0	30	1.0	115	55	60	35	50
					32	1.0	115	55	60	35	50
32	42.4	1.4	44.5	1.4	38	1.5	125	70	76	40	55
					40	1.4	125	70	76	40	55
40	48.3	1.8	51.0	1.9	50	1.9	150	75	81	40	75
50	60.3	3.3	57.0	3.5	63	3.4	170	90	97	40	85

**COMPRESSION FITTINGS ELBOW, CLAMPING ON BOTH SIDES FOR STEEL PIPES AND BLACK STEEL PIPES**

**FOR STEEL PIPES** 21.3 mm – 60.3 mm

**FOR BLACK STEEL PIPES** 20 mm – 63.5 mm

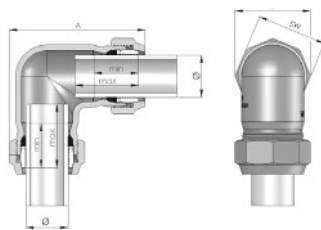

**COMPRESSION FITTINGS ELBOW, CLAMPING ON BOTH SIDES FOR PE PIPES WITH REINFORCEMENT SLEEVE**

**FOR PE PIPES** 20 mm – 63 mm

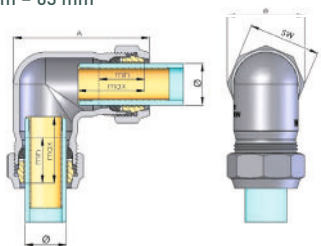

**TYPE WA** MALLEABLE CAST IRON COMPRESSION FITTINGS ELBOW, MALE THREAD

**FOR STEEL PIPES** DIN EN 10255 and DIN EN 10220 series 1

**MEDIA:** water, compressed air, heating oil (observe regulations for flammable liquids!), for gas (outside buildings)

**TEMPERATURES:** water: up to 25°C, heating water: up to 80°C, heating oil: 40°C; gas: -20°C to +60°C, compressed air: max. 70°C.

**SERIES 150:** 33.7 mm – 60.3 mm

**PRESSURE STAGES:**  
water PN 10 (up to 3/4") or PN 16 (from 1"), compressed air PN 12.5, oil PN 6, gas PN 5

**TESTS/APPROVALS:**  
water: DVGW W 534, DVGW Reg. No: DW-8511AU2216  
heating oil: Building approval DIBT, approval no.: Z-38.4-212  
gas: DIN 3387-1, DVGW Reg. No.: NG-4502AP1454  
technical approval national certificates  
hygienic certificate: national certificates



DN	Connecting thread x Pipe outer-Ø [mm]	Code
25	1 x 33.7	<b>01.150.09.03</b>
40	1 1/2" x 48.3	<b>01.150.09.05</b>
50	2" x 60.3	<b>01.150.09.06</b>

**TYPE WA** MALLEABLE CAST IRON COMPRESSION FITTINGS ELBOW, MALE THREAD

**FOR BLACK STEEL PIPES** DIN EN 10220 series 2 and 3

**MEDIA:** water, compressed air, heating oil only 57 mm (observe regulations for flammable liquids!)

**TEMPERATURES:** heating water: up to 80°C; oil: 40°C

**SERIES 150:** 20 mm – 63.5 mm

**PRESSURE STAGES:**  
water PN 6, compressed air PN 12.5, oil PN 6

**TESTS/APPROVALS:**  
heating oil: for 57 mm - building approval DIBT, approval no.: Z-38.4-212  
technical approval national certificates.



Product on request.

<b>TYPE WA</b>	<b>MALLEABLE CAST IRON COMPRESSION FITTINGS ELBOW, MALE THREAD</b>
<b>FOR PE PIPES</b>	PE 80, PE 100, PE-Xa (each SDR 11) according to DVGW work sheet GW 335 A2/A3 and DIN 8074/75, DIN EN 12201-2 and DIN 16893

**IT IS NECESSARY TO USE SUPPORT SLEEVES.**

These products are not included in the scope of delivery, so please order them separately. (see page xxx)



**SERIES 153/155:**  
32 mm – 63 mm

**MEDIA:**

Water, compressed air, for gas (outside buildings)

**PRESSURE STAGES:**

water (20°C): PE80 and PE-Xa PN 12.5, PE100 PN 16  
compressed air: PE80 and PE-Xa PN 10, PE100 PN 12.5  
Gas: PE80, PE100 and PE-Xa PN4

**TESTS/APPROVALS:**

water: DIN 8076/DIN EN 10284, DVGW: CW-7511CP0631;  
gas: DVGW work sheet G 5600-1, DVGW Reg. No.: DG-7521CP0412  
technical approval national certificate  
hygienic certificate: national certificate

DN	Connecting thread x Pipe outer-Ø [mm]	Code
25	1" x 32	<b>03.153.09.0332</b>
40	1 1/2" x 50	<b>03.153.09.0550</b>
50	2" x 63	<b>03.153.09.0663</b>

**DIMENSIONS AND WEIGHTS**

DN	Connecting thread R R ISO 7/1	STEEL PIPES		BLACK STEEL PIPES		PE PIPES		Length -A [mm]	Wrench size -SW [mm]	Corner dimension -e [mm]	Depth of insertion [mm]	
		Pipe outer-Ø [mm]	Weight [kg]	Pipe outer-Ø [mm]	Weight [kg]	Pipe outer-Ø [mm]	Weight [kg]				min.	max.
25	1"	33.7	0.6	31.8	0.6	32.0	0.7	115	55	60	35	50
40	1 1/2"	48.3	1.2	51.0	1.2	50.0	1.2	150	75	81	40	75
50	2"	60.3	2.2	57.0	2.3	63.0	2.2	170	90	97	40	85

**COMPRESSION FITTINGS ELBOW, MALE THREAD FOR STEEL PIPES AND BLACK STEEL PIPES**

**FOR STEEL PIPES** 33.7 mm – 60.3 mm

**FOR BLACK STEEL PIPES** 20 mm – 63.5 mm

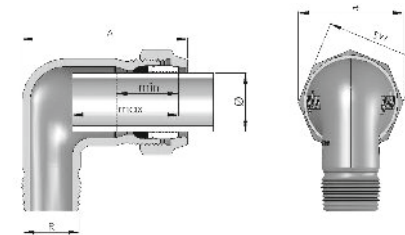

**COMPRESSION FITTINGS ELBOW, MALE THREAD FOR PE PIPES WITH REINFORCEMENT SLEEVE**

**FOR PE PIPES** 32 mm – 63 mm

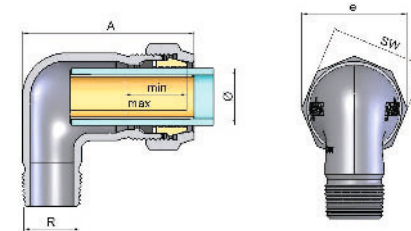

**TYPE EK AND EKF MALLEABLE CAST IRON END CAP**

**FOR STEEL PIPES** DIN EN 10255 and DIN EN 10220 series 1

**MEDIA:** water, compressed air, heating oil up to 2" (observe the regulations for flammable liquids!), for gas (outside buildings)

**OPERATING TEMPERATURE:** water: up to 25°C, heating water: up to 80°C, heating oil: 40°C; gas: -20°C to +60°C



**SERIES 150: SIZES:**  
21.3 mm - 60.3 mm

**PRESSURE STAGES:**

water PN 10 (up to 3/4") or PN 16 (from 1"),  
compressed air PN 12.5, oil PN 6, gas PN 5,  
fire extinguisher lines (VdS) PN 12.5

**TESTS/APPROVALS:**

water: DVGW W 534, DVGW Reg. No: DW-8511AU2216;  
fire extinguisher lines: (from size DN25 onwards) - VdS-tested  
heating oil: building approval DIBT, approval no.: Z-38.4-212  
gas: DIN 3387-1, DVGW Reg. No.: NG-4502AP1454  
technical approval national certificates  
hygienic certificate: national certificates

**SERIES 220:**  
76.1 mm

**PRESSURE STAGES:**

water PN 16  
compressed air PN 10  
fire extinguisher (VdS) PN 16, gas PN 5

**TESTS/APPROVALS:**

water: DVGW W 534, DVGW Reg. No.: DW-8511AU2217  
fire extinguisher lines: VdS-tested  
gas: DIN 3387-1, DVGW Reg. No.: NG-4502AP1491  
technical approval national certificates  
hygienic certificate: national certificates

DN	Pipe outer-Ø [mm]	Code
15	21.3 (1/2")	01.150.07.01
20	26.9 (3/4")	01.150.07.02
25	33.7 (1")	01.150.07.03
32	42.4 (1 1/4")	01.150.07.04
40	48.3 (1 1/2")	01.150.07.05
50	60.3 (2")	01.150.07.06
65	76.1 (2 1/2")	01.220.07.07

**TYPES EK and EKF MALLEABLE CAST IRON END CAPS**

**FOR BLACK STEEL PIPES** DIN EN 10220 series 2 and 3

**MEDIA:** water, compressed air, heating oil only 57 mm (observe regulations for flammable liquids!)

**TEMPERATURES:** heating water: up to 80°C; oil: 40°C

**SERIES 150:**  
20 mm - 63.5 mm

**PRESSURE STAGES:** water PN 6, compressed air PN 12.5, oil PN 6

**TESTS/APPROVALS:**

heating oil: for 57 mm - building approval DIBT, approval no.: Z-38.4-212,  
technical approval national certificates

**SERIES 220:**  
70 mm

**PRESSURE STAGES:** water PN 6, compressed air PN 10

DN	Pipe outer-Ø [mm]	Code
15	20.0	02.150.07.20
20	25.0	02.150.07.25
25	31.8	02.150.07.318
32	38.0	02.150.07.38
32	44.5	02.150.07.445
40	51.0	02.150.07.51
50	57.0	02.150.07.57
50	63.5	02.150.07.635
65	70.0	02.220.07.70

**TYPE EK MALLEABLE CAST IRON END CAPS**

**FOR PE PIPES** PE 80, PE 100, PE-Xa (each SDR 11) according to DVGW work sheet GW 335 A2/A3 and DIN 8074/75, DIN EN 12201-2 and DIN 16893

**IT IS NECESSARY TO USE SUPPORT SLEEVES.**

These products are not included in the scope of delivery, so please order them separately. (see page xxx)

**SERIES 153/155:**  
20 mm - 63 mm

**MEDIA:**

Water, compressed air, for gas (outside buildings)

**PRESSURE STAGES:**

water (20°C): PE80 and PE-Xa PN 12.5, PE100 PN 16  
compressed air: PE80 and PE-Xa PN 10, PE100 PN 12.5  
gas: PE100 PN 10, PE80 PN 4, PE-Xa PN 8

**TESTS/APPROVALS:**

water: DIN 8076/DIN EN 10284, DVGW Reg. No.: CW-7511CP0631;  
gas: DVGW work sheet G 5600-1, DVGW Reg. No.: DG-7521CP0412  
technical approval national certificates  
hygienic certificate: national certificates

DN	Pipe outer-Ø [mm]	Code
15	20.0	03.153.07.20
20	25.0	03.153.07.25
25	32.0	03.153.07.32
32	38.0*	03.153.07.38
32	40.0	03.153.07.40
40	50.0	03.153.07.50
50	63.0	03.153.07.63

\* - Not for gas applications.



**DIMENSIONS AND WEIGHTS**

DN	STEEL PIPES		BLACK STEEL PIPES		PE PIPES		Length - A [mm]	Wrench size or flange cover size - SW [mm]	Corner dimension - e [mm]	Depth of insertion [mm]	
	Pipe outer-Ø [mm]	Weight [kg]	Pipe outer-Ø [mm]	Weight [kg]	Pipe outer-Ø [mm]	Weight [kg]				min.	max.
20	26.9	0.4	25.0	0.3	25.0	0.4	53	50	54	30	40
25	33.7	0.5	31.8	0.4	30.0	0.5	55	55	60	35	40
32	42.4	0.8	44.5	0.6	32.0	0.5	55	55	60	35	40
					38.0	0.8	61	70	76	40	45
40	48.3	0.9	51.0	0.8	40.0	0.7	61	70	76	40	45
					50.0	0.9	63	75	81	40	50
50	60.3	1.3	57.0	1.3	63.0	1.3	72	90	97	40	55
					63.5	1.5	72	90	97	40	55
65	76.1	3.1	70.0	3.1			118	100	150	50	90

**COMPRESSION FITTING END CAP TYPE EK + EKF FOR STEEL PIPE AND BLACK STEEL PIPE**

<b>FOR STEEL PIPES</b>	21.3 mm – 60.3 mm und 76.1 mm
<b>FOR BLACK STEEL PIPES</b>	20 mm – 63.5 mm und 70mm

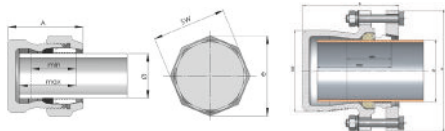

**COMPRESSION FITTING END CAP TYPE EK + EKF FOR PE PIPE INCL. SUPPORT SLEEVE**

<b>FOR PE PIPES</b>	20 mm – 63 mm
---------------------	---------------

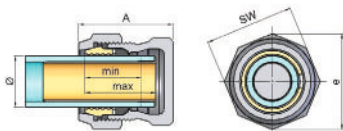

**SPARE PARTS SPARE PARTS SET FOR SERIES 150 + 220: COMPRESSION RING, WASHER AND SEAL**

**FOR STEEL PIPES** DIN EN 10255 and DIN EN 10220 series 1

- 3-part
- All parts are available individually!

**3-PART**

Pipe outer-Ø [mm]	Code
21.3 (1/2")	01.161.48.01
26.9 (3/4")	01.161.48.02
33.7 (1")	01.161.48.03
42.4 (1 1/4")	01.161.48.04
48.3 (1 1/2")	01.161.48.05
60.3 (2")	01.161.48.06
76.1 (2 1/2")	01.161.48.07
88.9 (3")	01.161.48.08
114.3 (4")	01.161.48.09



**NBR SEAL**

Pipe outer-Ø [mm]	Code
21.3 (1/2")	91000100
26.9 (3/4")	91000200
33.7 (1")	91000300
42.4 (1 1/4")	91000400
48.3 (1 1/2")	91000500
60.3 (2")	91000600
76.1 (2 1/2")	91000700
88.9 (3")	91000800
114.3 (4")	91000900

**WASHER**

Pipe outer-Ø [mm]	Code
21.3 (1/2")	91200100
26.9 (3/4")	91200200
33.7 (1")	91200300
42.4 (1 1/4")	91200400
48.3 (1 1/2")	91200500
60.3 (2")	91200600
76.1 (2 1/2")	91200700
88.9 (3")	91200800
114.3 (4")	91200900

**COMPRESSION RING**

Pipe outer-Ø [mm]	Code
21.3 (1/2")	91110100
26.9 (3/4")	91110200
33.7 (1")	91110300
42.4 (1 1/4")	91110400
48.3 (1 1/2")	91110500
60.3 (2")	91110600
76.1 (2 1/2")	91080700
88.9 (3")	91080800
114.3 (4")	00141000

SPARE PARTS

CONVERSION KIT FOR SERIES 150 + 220: COMPRESSION RING, WASHER AND SEAL

FOR BLACK STEEL PIPES

DIN EN 10220 Series 2 and 3

- 3-part
- For the pipes of diameters 38.0 mm, 44.5 mm, 51 mm, 63.5 mm and 82.5 mm only complete pipe connections can be supplied
- According to the size the compression rings are made of brass or galvanized steel



3-PART SERIES 150 + 220

Pipe outer-Ø [mm]	Code
20.0	02.163.48.20
25.0	02.163.48.25
31.8	02.163.48.318
57.0	02.163.48.57
70.0	02.163.48.70
108.0	02.163.48.108

SPARE PARTS

CONVERSION KIT FOR SERIES 153/155 AND 220 PE : COMPRESSION RING, WASHER AND SEAL

FOR PE PIPES

PE 80, PE 100, PE-Xa (each SDR 11) according to DVGW work sheet GW 335 A2/A3 and DIN 8074/75, DIN EN 12201-2 and DIN 16893

- 3-part
- For the pipes of diameters 50 mm and 63 mm, only complete pipe connections can be supplied



3-PART SERIES 153/155 + 220

Pipe outer-Ø [mm]	Code
20.0	03.162.48.20
25.0	03.162.48.25
30.0	03.162.48.30
32.0	03.162.48.32
38.0	03.162.48.38
40.0	03.162.48.40
75.0	03.162.48.75
90.0	03.162.48.90
110.0	03.162.48.110

SUPPORT SLEEVES

FOR PLASTIC PIPES

made of PE80, PE100 and PE-Xa

Pipe series S5, SDR 11



Pipe outer-Ø [mm]	Length [mm]	Code
20 x 1.9	60	03.354.75.2019
25 x 2.3	65	03.354.75.2523
32 x 2.9	70	03.354.75.3230
40 x 3.7	75	03.354.75.4037
50 x 4.6	80	03.354.75.5046
63 x 5.8	90	03.354.75.6358

ASSEMBLY INSTRUCTIONS

FOR STEEL PIPES

DIN EN 10255 and DIN 10220 series 1

SERIES 150

DIMENSIONS:

Connection threads ISO 7/1	Pipe outer-Ø [mm]
3/8"	17.2
1/2"	21.3
3/4"	26.9
1"	33.7
1 1/4"	42.4
1 1/2"	48.3
2"	60.3

ASSEMBLY PROCEDURE:

The slotted compression ring (2) design allows a straight as well as angled assembly of the pipes to be connected.

Straight installation: Compression ring (2) with the marking groove side (3) in the direction of the cone nut (1)

Angular installation: Compression ring with marking groove side (3) in the direction of the sealing chamber (6)

1. Cut the pipe end to be connected at right angles to the axis. The pipe end must be free from burr, un-deformed and without threads. Remove paint coating and contamination.
2. Slide cone nut (1), compression ring (2), washer (4) and seal (5) on the pipe end as shown.
3. Slide the seal (5) minimum 10 mm above the pipe end.
4. Slide in the pipe end with the individual elements into the sealing chamber (6) of the fitting body (7); check for perfect fit.
5. Thread on and tighten the cone nut (1) with the fitting body (7). Prevent the tube from turning along.

**If using a torque wrench, use the following torque as guide values:**  
 3/8" - 1" = 150 Nm · 1 1/4" - 2" = 200 Nm

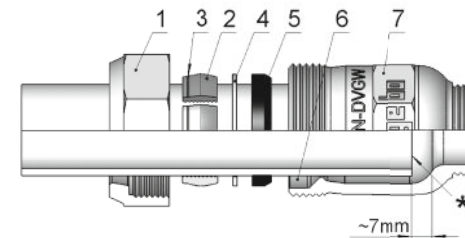

- 1 Cone nut
- 2 Compression ring
- 3 Marking groove
- 4 Washer
- 5 Seal
- 6 Sealing chamber
- 7 Fitting body

\* Respect the installation length! Pipes may not be inserted up to the end stop or in the case of couplings not abut.

**ASSEMBLY INSTRUCTIONS**

**FOR PE-PIPES**

PE 80, PE 100, PE-Xa [each SDR 11] according to DVGW work sheet GW 335 A2/A3 and DIN 8074/75, DIN EN 12201-2 and DIN 16893

**SERIES 153/155**

**DIMENSIONS:**

Connection threads ISO 7/1	Pipe Outer-Ø x wall thickness [mm]
1/2"	20 x 1.9
3/4"	25 x 2.3
1"	32 x 2.9
1 1/4"	40 x 3.7
1 1/2"	50 x 4.6
2"	63 x 5.8

**ASSEMBLY PROCEDURE (INCLUDING SUPPORT SLEEVE):**

1. Cut the pipe end to be connected at right angles to the axis.
2. Mark length of support sleeve on the pipe end.
3. Slide cone nut (1), compression ring (2), washer (3) and seal (4) on the pipe end, as shown. Slide in the support sleeve (7) into the pipe end.
4. Slide the seal (4) minimum 10 mm above the pipe end.
5. The support sleeve must project beyond the clamping element by at least 10 mm.
6. Slide in the pipe end with the individual elements into the sealing chamber (5) of the fitting body (6); check for perfect fit.
7. Thread on and tighten the cone nut (1) with the fitting (6).

**If using a torque wrench, use the following torque as guide values:**

- 20 mm, 25 mm = 100 Nm**
- 32 – 50 mm = 140 Nm**
- 63 mm = 180 Nm**

- 1 Cone nut
- 2 Compression ring
- 3 Washer
- 4 Seal
- 5 Sealing chamber
- 6 Fitting body
- 7 support sleeve

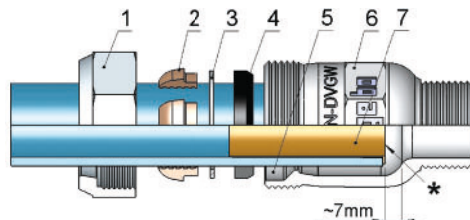

\* Respect the installation length! Pipes may not be inserted up to the end stop or in the case of couplings not abut.

**ASSEMBLY INSTRUCTIONS**

**FOR STEEL PIPES**

DIN EN 10255, DIN 2442 and DIN 2448/DIN 2458 Series 1, ISO 65

**SERIES 220**

**DIMENSIONS:**

Connection threads ISO 7/1	Pipe outer-Ø [mm]
2 1/2"	76.1
3"	88.9
4"	114.3

**ASSEMBLY PROCEDURE:**

1. Cut the pipe end to be connected at right angles to the axis. The pipe end must be free from burr, un-deformed and without threads. Paint applications and contamination must be removed.
  2. Slide flange (1), compression ring (2), washer (3) and seal (4) on the pipe end, as shown.
  3. Slide the seal (4) minimum 10 mm above the pipe end.
  4. Insert pipe end with the individual elements in the fitting body (5), check for perfect fit.
  5. Thread on the flange (1) and fitting body (5) crosswise.
- Tightening torque for screws (torque wrench) 50 Nm.

**After allowing a 5 minutes setting time, tighten the screws once again.**

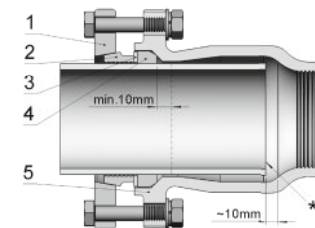

- 1 Flange cover
- 2 Compression ring
- 3 Washer
- 4 Seal
- 5 Fitting body

\* Respect the installation length! Pipes may not be inserted up to the end stop or in the case of couplings not abut.

**ASSEMBLY INSTRUCTIONS**

**FOR PE-PIPES**

PE 80, PE 100, PE-Xa (each SDR 11) according to DVGW work sheet GW 335 A2/A3 and DIN 8074/75, DIN EN 12201-2 and DIN 16893

**SERIES 220 PE**

**DIMENSIONS:**

Connection threads ISO 7/1	Pipe Outer-Ø x wall thickness [mm]
2 1/2"	75 x 6,8
3"	90 x 8,2
4"	110 x 10

**Assembly procedure** (including support sleeve):

1. Slide flange (1), compression ring (2), washer (3) and seal (4) on the pipe end, as shown.
2. Insert support sleeve (7) up to the stop into the pipe end to be connected. Mark the length of the support sleeve on the pipe end in advance.
3. Slide the seal (4) minimum 10 mm above the pipe end.
4. Insert pipe end with the individual elements in the fitting body (5), check for perfect fit.  
The compression ring must be placed at least 10 mm before the marking of the support sleeve length!
5. Thread on the flange (1) and fitting body (5) crosswise.  
Tightening torque for screws (torque wrench) 50 Nm.

**After allowing a 5 minutes setting time, tighten the screws once again.**

- 1 Flange cover
- 2 Compression ring
- 3 Washer
- 4 Seal
- 5 Sealing chamber
- 6 Fitting body
- 7 Support sleeve

\* Respect the installation length! Pipes may not be inserted up to the end stop or in the case of couplings not abut.

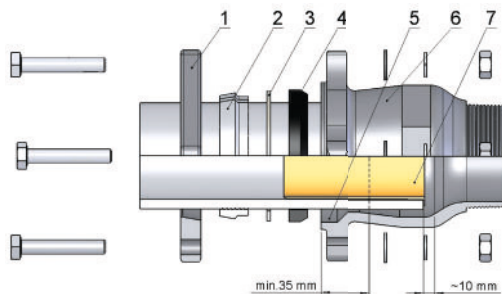

THINGS TO KNOW ABOUT OUT HIGH TEMPERATURES-RESISTANT CAST MALLEABLE IRON COMPRESSION FITTINGS SERIES 180 + 225:

SPECIALLY SUITABLE FOR GAS INSTALLATION INSIDE BUILDINGS

**OUR HTB-COMPRESSION FITTINGS ARE:**

- fire-resistant, that means that they can withstand for 30 minutes temperatures up to 650 °
- suitable for long term use
- restrained, that means resistant to tensile and shearing strength
- bending possible up to 3°, for couplings 2 x 3° = 6°
- suitable as potential balancing

**MATERIALS USED**

Fitting body:	Malleable cast iron EN-GJMB 350-10, EN 1562
Cone nut/Flange:	Malleable cast iron EN-GJMB 350-10, EN 1562
Compression ring:	Galvanised steel yellow
Washer:	Galvanised steel
O-Ring seal:	NBR
Fire-proof ring seal:	Graphite
Galvanisation:	Hot-dip galvanising of the fitting bodies, flange plates and cone nuts (Hot dip galvanising according to DIN EN 10242) The exposure of surfaces occurring in the course of machining is galvanically zinc coated. Steel compression rings and washers are also galvanically zinc coated
Connecting threads:	conforming to ISO 7/1 respectively DIN EN 10226/1

**AREAS OF APPLICATION**

Repairs to existing pipelines and new installation of pipelines for the domestic gas installation for gases accordingly DVGW work sheet G 260

High temperature-resistant compression fittings of cast malleable iron for steel pipe:  
Threaded pipe conforming to DIN EN 10255 and DIN EN 10220 series 1

Typical areas of application: Repairs of gas lines inside buildings  
New installation of gas lines inside buildings  
The HTB compression fitting is often used as a binding link between house introduction combination with main locking device and internal line installation.

TYPE AT + AFT	WITH MALE THREAD
FOR STEEL PIPES	DIN EN 10255 and DIN EN 10220 series 1

**MEDIA:** Gas

**TEMPERATURES:** Gas: -20°C to +60°C

**SERIES 180:**  
21.3 – 60.3 mm

**PRESSURE STAGES:**

Gas: PN 5

**TESTS/APPROVALS:**

Gas DIN 3387-1, DVGW-Reg.-Nr.: NG-4502AP1417

**SERIES 225:**  
76.1 – 114.3 mm

**PRESSURE STAGES:**

Gas: PN 1

**TESTS/APPROVALS:**

Gas DIN 3387-1, DVGW-Reg.-Nr.: NG-4502AP1474



DN	CONNECTING THREAD X PIPE OUTER-Ø [MM]	CODE
15	1/2" x 21.3	01.180.00.01
20	3/4" x 26.9	01.180.00.02
25	1" x 33.7	01.180.00.03
32	1 1/4" x 42.4	01.180.00.04
40	1 1/2" x 48.3	01.180.00.05
50	2" x 60.3	01.180.00.06
65	2 1/2" x 76.1	01.225.00.07
80	3" x 88.9	01.225.00.08
100	4" x 114.3	01.225.00.09

**DIMENSIONS AND WEIGHTS**

DN	CONNECTING THREAD R ISO 7/1	STEEL PIPE		LENGTH -A [MM]	WRENCH SIZE OR DIMENSION FLANGE COVER -SW [MM]	CORNER DIMENSION -E [MM]	DEPTH OF INSERTION [MM]	
		PIPE OUTER-Ø [MM]	WEIGHT [KG]				MIN.	MAX.
20	3/4"	26.9	0.5	100	50	54	30	70
25	1"	33.7	0.6	100	55	60	35	65
32	1 1/4"	42.4	0.8	115	70	76	40	70
40	1 1/2"	48.3	1.1	115	75	81	40	75
50	2"	60.3	1.7	130	90	97	40	85
65	2 1/2"	76.1	3.2	160	100	150	50	95
80	3"	88.9	4.6	185	120	160	50	105
100	4"	114.3	6.1	180	135	180	50	105

\*high-temperature-resistant version for domestic gas installation





**TYPE IT + IFT WITH FEMALE THREAD**

**FOR STEEL PIPE** DIN EN 10255 and DIN EN 10220 series 1

**MEDIA:** Gas

**TEMPERATURES:** Gas: -20°C to +60°C



**SERIES 180:**  
21.3 – 60.3 mm

**PRESSURE STAGES:**

Gas: PN 5

**TESTS/APPROVALS:**

Gas DIN 3387-1, DVGW-Reg.-Nr.: NG-4502AP1417



**SERIES 225:**  
76.1 – 114.3 mm

**PRESSURE STAGES:**

Gas: PN 1

**TESTS/APPROVALS:**

Gas DIN 3387-1, DVGW-Reg.-Nr.: NG-4502AP1474

DN	CONNECTING THREAD X PIPE OUTER-Ø [MM]	CODE
15	1/2" x 21.3	01.180.01.01
20	3/4" x 26.9	01.180.01.02
25	1" x 33.7	01.180.01.03
32	1 1/4" x 42.4	01.180.01.04
40	1 1/2" x 48.3	01.180.01.05
50	2" x 60.3	01.180.01.06
65	2 1/2" x 76.1	01.225.01.07
80	3" x 88.9	01.225.01.08
100	4" x 114.3	01.225.01.09

**DIMENSIONS AND WEIGHTS**

DN	CONNECTING THREAD Rp ISO 7/1	STEEL PIPE		LENGTH -A [MM]	WRENCH SIZE OR DIMENSION FLANGE COVER -SW [MM]	CORNER DIMENSION -E [MM]	DEPTH OF INSERTION [MM]	
		PIPE OUTER-Ø [MM]	WEIGHT [KG]				MIN.	MAX.
20	3/4"	26.9	0.6	100	50	54	30	70
25	1"	33.7	0.6	100	55	60	35	65
32	1 1/4"	42.4	1.0	115	70	76	40	70
40	1 1/2"	48.3	1.2	115	75	81	40	75
50	2"	60.3	1.7	130	90	97	40	85
65	2 1/2"	76.1	3.2	155	100	150	50	95
80	3"	88.9	4.1	170	120	160	50	105
100	4"	114.3	5.3	160	135	180	50	105

\*high-temperature-resistant version for domestic gas installation

**TYPE OT + OFT FOR CLAMPING ON BOTH SIDES**

**FOR STEEL PIPE** DIN EN 10255 and DIN EN 10220 series 1

**MEDIA:** Gas

**TEMPERATURES:** Gas: -20°C to +60°C



**SERIES 180:**  
21.3 – 60.3 mm

**PRESSURE STAGES:**

Gas: PN 5

**TESTS/APPROVALS:**

Gas DIN 3387-1, DVGW-Reg.-Nr.: NG-4502AP1417



**SERIES 225:**  
76.1 – 114.3 mm

**PRESSURE STAGES:**

Gas: PN 1

**TESTS/APPROVALS:**

Gas DIN 3387-1, DVGW-Reg.-Nr.: NG-4502AP1474

DN	PIPE OUTER-Ø [MM]	CODE
15	21.3 x 21.3 [1/2"]	01.180.02.01
20	26.9 x 26.9 [3/4"]	01.180.02.02
25	33.7 x 33.7 [1"]	01.180.02.03
32	42.4 x 42.4 [1 1/4"]	01.180.02.04
40	48.3 x 48.3 [1 1/2"]	01.180.02.05
50	60.3 x 60.3 [2"]	01.180.02.06
65	76.1 x 76.1 [2 1/2"]	01.225.02.07
80	88.9 x 88.9 [3"]	01.225.02.08
100	114.3 x 114.3 [4"]	01.225.02.09

**DIMENSIONS AND WEIGHTS**

DN	STEEL PIPE		LENGTH -A [MM]	WRENCH SIZE OR DIMENSION FLANGE COVER -SW [MM]	CORNER DIMENSION -E [MM]	DEPTH OF INSERTION [MM]	
	PIPE OUTER-Ø [MM]	WEIGHT [KG]				MIN.	MAX.
20	26.9	0.7	100	50	54	30	70
25	33.7	0.8	100	55	60	35	65
32	42.4	1.4	115	70	76	40	70
40	48.3	1.6	115	75	81	40	75
50	60.3	2.2	130	90	97	40	85
65	76.1	5.2	210	./.	150	50	95
80	88.9	6.0	220	./.	160	50	105
100	114.3	7.6	210	./.	180	50	105

\*high-temperature-resistant version for domestic gas installation

COMPRESSION FITTINGS FOR STEEL PIPE TYPE AT + AFT

**FOR STEEL PIPE** 21.3 mm – 60.3 mm  
76.1 mm – 114.3 mm

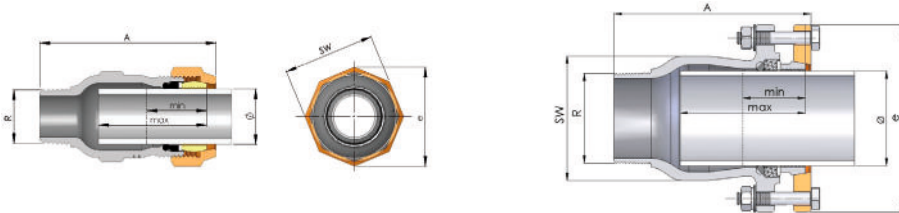

COMPRESSION FITTINGS FOR STEEL PIPE TYPE IF + IFT

**FOR STEEL PIPE** 21.3 mm – 60.3 mm  
76.1 mm – 114.3 mm

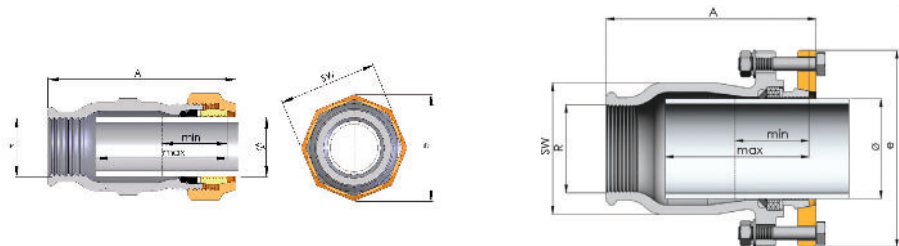

COMPRESSION FITTINGS FOR STEEL PIPE TYPE OT + OFT

**FOR STEEL PIPE** 21.3 mm – 60.3 mm  
76.1 mm – 114.3 mm

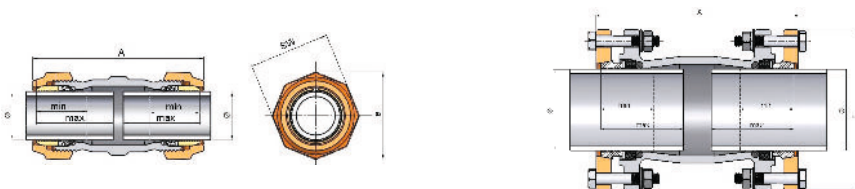

\*high-temperature-resistant version for domestic gas installation

TYPE TT + TFT

OUTLET WITH FEMALE THREAD, CLAMPING ON BOTH SIDES

**FOR STEEL PIPE** DIN EN 10255 and DIN EN 10220 series 1

**MEDIA:** Gas

**TEMPERATURES:** Gas: -20°C to +60°C

**SERIES 180:**  
21.3 – 60.3 mm

**PRESSURE STAGES:**

Gas: PN 5

**TESTS/APPROVALS:**

Gas DIN 3387-1, DVGW-Reg.-Nr.: NG-4502AP1417

**SERIES 225:**  
76.1 – 114.3 mm

**PRESSURE STAGES:**

Gas: PN 1

**TESTS/APPROVALS:**

Gas DIN 3387-1, DVGW-Reg.-Nr.: NG-4502AP1474



DN	PIPE OUTER-Ø [MM] XCONNECTING THREAD. 1 x 2 x 3	CODE
15	21.3 x 21.3 x 1/2"	01.180.04.01
20	26.9 x 26.9 x 3/4"	01.180.04.02
25	33.7 x 33.7 x 1"	01.180.04.03
32	42.4 x 42.4 x 1 1/4"	01.180.04.04
40	48.3 x 48.3 x 1 1/2"	01.180.04.05
50	60.3 x 60.3 x 2"	01.180.04.06
65	76.1 x 76.1 x 2 1/2"	01.225.04.07
80	88.9 x 88.9 x 3"	01.225.04.08
100	114.3 x 114.3 x 4"	01.225.04.09

DIMENSIONS AND WEIGHTS

DN	CONNECTING THREAD R ISO 7/1	STEEL PIPE		LENGTH -A [MM]	WRENCH SIZE OR DIMEN- SION FLANGE COVER -SW [MM]	CORNER DIMENSION -E [MM]	DEPTH OF INSERTION [MM]	
		PIPE OUTER-Ø [MM]	WEIGHT [KG]				MIN.	MAX
15	1/2"	21.3	0.5	125	41	44	30	70
20	3/4"	26.9	0.8	138	50	54	30	70
25	1"	33.7	0.9	145	55	60	35	65
32	1 1/4"	42.4	1.4	148	70	76	40	70
40	1 1/2"	48.3	1.7	162	75	81	40	75
50	2"	60.3	2.5	190	90	97	40	85
65	2 1/2"	76.1	6.0	260	./.	150	50	95
80	3"	88.9	7.5	290	./.	160	50	105
100	4"	114.3	9.1	290	./.	180	50	105

\*high-temperature-resistant version for domestic gas installation

COMPRESSION FITTINGS FOR STEEL PIPE TYPE TT + TFT

FOR STEEL PIPE

21.3 mm – 60.3 mm

76.1 mm – 114.3 mm

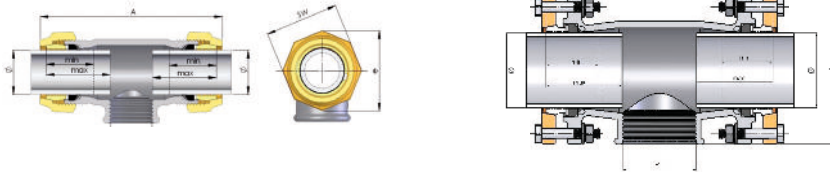

\*high-temperature-resistant version for domestic gas installation

TYPE OLT

CLAMPING ON BOTH SIDES, LONG VERSION

FOR STEEL PIPE

DIN EN 10255 and DIN EN 10220 series 1

MEDIA: Gas

TEMPERATURES: Gas: -20°C to +60°C

SERIES 180:

21.3 – 60.3 mm

PRESSURE STAGES:

Gas: PN 5

TESTS/APPROVALS::

Gas DIN 3387-1, DVGW-Reg.-Nr.: NG-4502AP1417



DN	PIPE OUTER-Ø [MM]	CODE
15	21.3 x 21.3 (1/2")	01.180.03.01
20	26.9 x 26.9 (3/4")	01.180.03.02
25	33.7 x 33.7 (1")	01.180.03.03
32	42.4 x 42.4 (1 1/4")	01.180.03.04
40	48.3 x 48.3 (1 1/2")	01.180.03.05
50	60.3 x 60.3 (2")	01.180.03.06

DIMENSIONS AND WEIGHTS

DN	STEEL PIPE		LENGTH -A [mm]	WRENCH SIZE -SW [MM]	CORNER DIMENSION -E [MM]	DEPTH OF INSERTION [MM]	
	PIPE OUTER-Ø [MM]	WEIGHT [KG]				MIN.	MAX.
20	26.9	1.2	230	50	54	30	100
25	33.7	1.3	230	55	60	35	100
32	42.4	2.0	230	70	76	40	100
40	48.3	2.6	230	75	81	40	100
50	60.3	3.1	230	90	97	40	100

COMPRESSION FITTINGS FOR STEEL PIPE TYPE OLT

FOR STEEL PIPE

21.3 mm – 60.3 mm

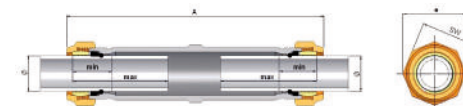

\*high-temperature-resistant version for domestic gas installation



<b>TYPE ORT</b>	<b>CLAMPING ON BOTH SIDES, REDUCED</b>
<b>FOR STEEL PIPE</b>	DIN EN 10255 and DIN EN 10220 series 1

**MEDIA:** Gas

**TEMPERATURES:** Gas: -20°C to +60°C



**SERIES 180:**  
33.7 – 60.3 mm

**PRESSURE STAGES:**

Gas: PN 5

**TESTS/APPROVALS:**

Gas DIN 3387-1, DVGW-Reg.-Nr.: NG-4502AP1417

DN	PIPE OUTER-Ø [MM]	CODE
25 x 20	33.7 x 26.9 (1" x 3/4")	<b>01.180.02.0302</b>
32 x 20	42.4 x 26.9 (1 1/4" x 3/4")	<b>01.180.02.0402</b>
32 x 25	42.4 x 33.7 (1 1/4" x 1")	<b>01.180.02.0403</b>
40 x 25	48.3 x 33.7 (1 1/2" x 1")	<b>01.180.02.0503</b>
40 x 32	48.3 x 42.4 (1 1/2" x 1 1/4")	<b>01.180.02.0504</b>
50 x 32	60.3 x 42.4 (2" x 1 1/4")	<b>01.180.02.0604</b>
50 x 40	60.3 x 48.3 (2" x 1 1/2")	<b>01.180.02.0605</b>

**DIMENSIONS AND WEIGHTS**

DN	STEEL PIPE		LENGTH -A [MM]	WRENCH SIZE -SW [MM]	CORNER DIMENSION -E [MM]	DEPTH OF INSERTION [MM]		
	PIPE OUTER-Ø [MM]	WEIGHT [KG]				MIN. 1	MIN. 2	MAX.
25 x 20	33.7 x 26.9	0.8	117	55	60	35	30	50
32 x 20	42.4 x 26.9	1.1	130	70	76	40	30	55
32 x 25	42.4 x 33.7	1.1	130	70	76	40	35	55
40 x 25	48.3 x 33.7	1.3	130	75	81	40	35	55
40 x 32	48.3 x 42.4	1.5	130	75	81	40	40	55
50 x 32	60.3 x 42.4	2.1	145	90	97	40	40	65
50 x 40	60.3 x 48.3	2.1	145	90	97	40	40	65

**COMPRESSION FITTINGS FOR STEEL PIPE TYPE ORT**

**FOR STEEL PIPE** 33.7 mm – 60.3 mm

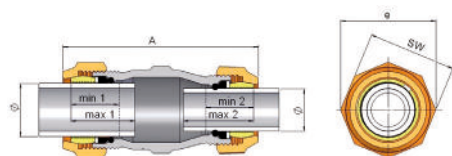

\*high-temperature-resistant version for domestic gas installation

<b>TYPE WOT</b>	<b>ELBOW, CLAMPING ON BOTH SIDES</b>
<b>FOR STEEL PIPE</b>	DIN EN 10255 and DIN EN 10220 series 1

**MEDIA:** Gas

**TEMPERATURES:** Gas: -20°C to +60°C

**SERIES 180:**  
21.3 – 60.3 mm

**PRESSURE STAGES:**

Gas: PN 5

**TESTS/APPROVALS:**

Gas DIN 3387-1, DVGW-Reg.-Nr.: NG-4502AP1417

DN	PIPE OUTER-Ø [MM]	CODE
15	21.3 x 21.3 (1/2")	<b>01.180.08.01</b>
20	26.9 x 26.9 (3/4")	<b>01.180.08.02</b>
25	33.7 x 33.7 (1")	<b>01.180.08.03</b>
32	42.4 x 42.4 (1 1/4")	<b>01.180.08.04</b>
40	48.3 x 48.3 (1 1/2")	<b>01.180.08.05</b>
50	60.3 x 60.3 (2")	<b>01.180.08.06</b>

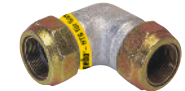

**DIMENSIONS AND WEIGHTS**

DN	STEEL PIPE		LENGTH -A [MM]	WRENCH SIZE OR DIMENSION FLANGE COVER -SW [MM]	CORNER DIMENSION -E [MM]	DEPTH OF INSERTION [MM]	
	PIPE OUTER-Ø [MM]	WEIGHT [KG]				MIN.	MAX.
15	21.3	0.5	100	41	44	30	50
20	26.9	0.8	105	50	54	30	50
25	33.7	1.0	115	55	60	35	50
32	42.4	1.6	125	70	76	40	55
40	48.3	1.9	150	75	81	40	75
50	60.3	3.1	170	90	97	40	85

**COMPRESSION FITTINGS FOR STEEL PIPE TYPE WOT**

**FOR STEEL PIPE** 21.3 mm – 60.3 mm

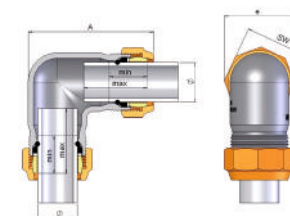

\*high-temperature-resistant version for domestic gas installation



<b>TYPE WAT</b>	<b>ELBOW WITH MALE THREAD</b>
<b>FOR STEEL PIPE</b>	DIN EN 10255 and DIN EN 10220 series 1

**MEDIA:** Gas

**TEMPERATURES:** Gas: -20°C to +60°C



<b>SERIES 180:</b> 33.7 - 60.3 mm		
<b>PRESSURE STAGES:</b> Gas: PN 5		
<b>TESTS/APPROVALS:</b> Gas DIN 3387-1, DVGW-Reg.-Nr.: NG-4502AP1417		
DN	PIPE OUTER-Ø [MM]	CODE
25	1" x 33.7	<b>01.180.09.03</b>
40	1 1/2" x 48.3	<b>01.180.09.05</b>
50	2" x 60.3	<b>01.180.09.06</b>

**DIMENSIONS AND WEIGHTS**

DN	CONNECTING THREAD R ISO 7/1	STEEL PIPE		LENGTH -A [MM]	WRENCH SIZE -SW [MM]	CORNER DIMENSION -E [MM]	DEPTH OF INSERTION [MM]	
		PIPE OUTER-Ø [MM]	WEIGHT [KG]				MIN.	MAX.
40	1 1/2"	48.3	1.3	150	75	81	40	75
50	2"	60.3	2.0	170	90	97	40	85

**COMPRESSION FITTINGS FOR STEEL PIPE TYPE WAT**

<b>FOR STEEL PIPE</b>	33.7 mm - 60.3 mm
-----------------------	-------------------

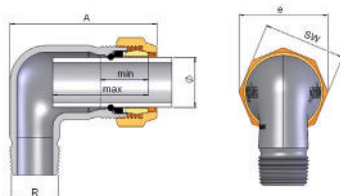

\*high-temperature-resistant version for domestic gas installation

<b>TYPE EKT + EKFT</b>	<b>END CAP</b>
<b>FOR STEEL PIPE</b>	DIN EN 10255 and DIN EN 10220 series 1

**MEDIA:** Gas

**TEMPERATURES:** Gas: -20°C to +60°C

<b>SERIES 180:</b> 21.3 - 60.3 mm	
<b>PRESSURE STAGES:</b> Gas: PN 5	
<b>TESTS/APPROVALS:</b> Gas DIN 3387-1, DVGW-Reg.-Nr.: NG-4502AP1417	



<b>SERIES 225:</b> 76.1 mm	
<b>PRESSURE STAGES:</b> Gas: PN 1	
<b>TESTS/APPROVALS:</b> Gas DIN 3387-1, DVGW-Reg.-Nr.: NG-4502AP1474	



DN	PIPE OUTER-Ø [MM]	CODE
15	21.3 [1/2"]	<b>01.180.07.01</b>
20	26.9 [3/4"]	<b>01.180.07.02</b>
25	33.7 [1"]	<b>01.180.07.03</b>
32	42.4 [1 1/4"]	<b>01.180.07.04</b>
40	48.3 [1 1/2"]	<b>01.180.07.05</b>
50	60.3 [2"]	<b>01.180.07.06</b>
65	76.1 [2 1/2"]	<b>01.225.07.07</b>

**DIMENSIONS AND WEIGHTS**

DN	STEEL PIPE		LENGTH -A [MM]	WRENCH SIZE OR DIMEN- SION FLANGE COVER -SW [MM]	CORNER DIMENSION -E [MM]	DEPTH OF INSERTION [MM]	
	PIPE OUTER-Ø [MM]	WEIGHT [KG]				MIN.	MAX.
20	26.9	0.4	53	50	54	30	40
25	33.7	0.5	55	55	60	35	40
32	42.4	0.8	61	70	76	40	45
40	48.3	0.9	63	75	81	40	50
50	60.3	1.4	72	90	97	40	55
65	76.1	3.2	118	100	150	50	90

\*high-temperature-resistant version for domestic gas installation

END CAP, COMPRESSION FITTINGS FOR STEEL PIPE TYPE EKT + EKFT

FOR STEEL PIPE

21.3 mm – 60.3 mm

76.1 mm

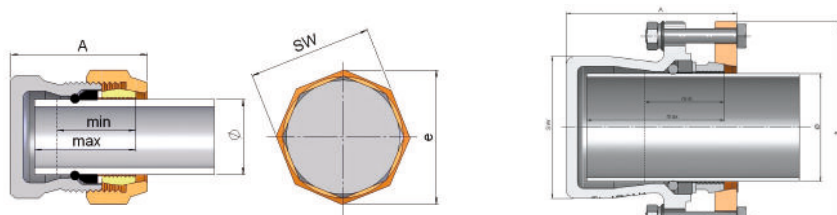

\*high-temperature-resistant version for domestic gas installation

SPARE PARTS

NBR O-RING, GRAPHITE RING, WASHER AND COMPRESSION RING

FOR STEEL PIPE

- High-temperature resistant design
- **Caution: HTB clamping and sealing elements may only be used in compression fittings, which bear a distinct yellow marking „HTB for Gas“ and have yellow galvanised cone nuts.**

These compression fittings have special dimensions in the sealing chamber area. A flexible-sealing Gebo compression fitting can never be converted to an HTB compression fitting, as this voids the warranty.

O-RING NBR

PIPE OUTER-Ø [MM]	CODE
21.3 [1/2"]	91020100
26.9 [3/4"]	00062700
33.7 [1"]	00062800
42.4 [1 1/4"]	00062900
48.3 [1 1/2"]	00063000
60.3 [2"]	00063100
76.1 [2 1/2"]	00063900
88.9 [3"]	00064000
114.3 [4"]	00064100



GRAPHITE RING

PIPE OUTER-Ø [MM]	CODE
21.3 [1/2"]	91010100
26.9 [3/4"]	91010200
33.7 [1"]	91010300
42.4 [1 1/4"]	91010400
48.3 [1 1/2"]	91010500
60.3 [2"]	91010600
76.1 [2 1/2"]	22560700
88.9 [3"]	22560800
114.3 [4"]	22560900

WASHER

PIPE OUTER-Ø [MM]	CODE
21.3 [1/2"]	91200100
26.9 [3/4"]	91200200
33.7 [1"]	91200300
42.4 [1 1/4"]	91200400
48.3 [1 1/2"]	91200500
60.3 [2"]	91200600
76.1 [2 1/2"]	91200700
88.9 [3"]	91200800
114.3 [4"]	91200900

\*high-temperature-resistant version for domestic gas installation

**HTB SPARE PART: COMPRESSION RING**

PIPE OUTER-Ø [MM]	CODE
21.3 [1/2"]	18110100
26.9 [3/4"]	18110200
33.7 [1"]	18110300
42.4 [1 1/4"]	18110400
48.3 [1 1/2"]	18110500
60.3 [2"]	18110600
76.1 [2 1/2"]	91080700
88.9 [3"]	91080800
114.3 [4"]	00141000

\*high-temperature-resistant version for domestic gas installation

**HTB SERIES 180: ASSEMBLY INSTRUCTIONS**

**FOR STEEL PIPE** DIN EN 10255 and DIN EN 10220 series 1

**Max. operating pressure:** Gas: 5 bar  
**Temperature:** -20 °C to +60 °C. Higher thermal loading capacity up to 650 °C for 30 minutes.  
**Media:** All gases conforming to DVGW – Worksheet G 260  
**Tests/approvals:** Tested for gas according to DIN 3387-1, DIN DVGW Reg.-Nr.: NG- 4502 AP 1417  
**Range of application:** Installation for gas lines inside buildings.

**SERIES 180:**

CONNECTING THREAD ISO 7/1	PIPE OUTER-Ø [MM]
1/2"	21.3
3/4"	26.9
1"	33.7
1 1/4"	42.4
1 1/2"	48.3
2"	60.3

**ASSEMBLY PROCEDURE:**

1. Cut the pipe end to be connected at right angles to the axis. The pipe end must be **free from burr, un-deformed and without threads**. Paint applications and contamination must be removed.
  2. Slide cone nut (1), compression ring (2), washer (3), graphite ring (4) and O-ring (5) on the pipe end as shown.
  3. Slide O-ring (5) at least 10 mm above the pipe end.
  4. Insert the pipe end with the individual elements in sealing chamber (6) of the fitting body (7); check for perfect fit.
  5. Thread on and tighten the cone nut (1) with the fitting body (7).
- Caution:** In order to avoid damage to the seal element, neither the pipe nor the fitting body should rotate during assembly.

**If using a torque wrench, use the following torque as guide values:**  
 1/2" – 1" = 150 Nm  
 1 1/4" – 2" = 200 Nm

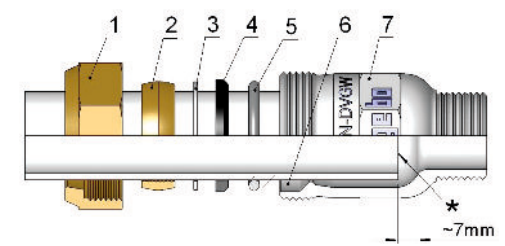

- 1 Cone nut
- 2 Compression ring
- 3 Washer
- 4 Graphite ring
- 5 O-ring
- 6 Sealing chamber
- 7 Fitting body

\* **Respect the installation length!** Pipes may not be inserted up to the end stop or in the case of couplings not abut.

\*high-temperature-resistant version for domestic gas installation



**HTB SERIES 225: ASSEMBLY INSTRUCTIONS**

**FOR STEEL PIPE**

DIN EN 10255 and DIN EN 10220 series 1

**Max. operating pressure:** Gas: 1 bar

**Temperature:** -20 °C to +60 °C. Higher thermal loading capacity up to 650 °C for 30 minutes.

**Media:** All gases conforming to DVGW – Worksheet G 260

**Tests/approvals:** Tested for gas according to DIN 3387-1, DIN DVGW Reg.-Nr.: NG- 4502 AP 1474

**Range of application:** Installation for gas lines inside buildings.

**SERIES 225:**

CONNECTION THREAD ISO 7/1	PIPE OUTER-Ø [MM]
2 1/2"	76.1
3"	88.9
4"	114.3

**ASSEMBLY PROCEDURE:**

1. Cut the pipe end to be connected at right angles to the axis. The pipe end must be **free from burr, un-deformed and without threads**. Paint applications and contamination must be removed.
  2. Slide flange (1), compression ring (2), washer (3), graphite ring (4) and O-ring (5) on the pipe end as shown.
  3. Slide O-ring (5) at least 10 mm above the pipe end.
  4. Insert pipe end with the individual elements in the fitting body (6); check for perfect fit.
  5. Thread on and tighten the flange (1) with the fitting body (6).
  6. Thread on the flange (1) and fitting body (6) crosswise.
- Tightening torque for screws (torque wrench) 50 Nm.

**After allowing a 5 minutes setting time, tighten the screws once again.**

- 1 Flange cover
- 2 Compression ring
- 3 Washer
- 4 Graphite ring
- 5 O-ring
- 6 Fitting body\* **Respect the installation length!** Pipes may not be inserted up to the end stop or in the case of couplings not abut.

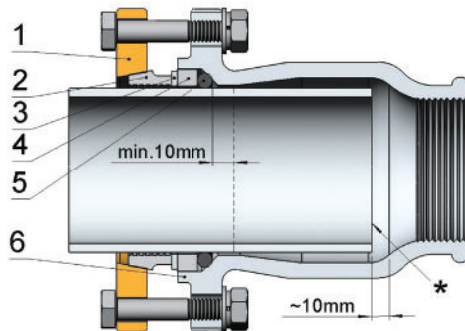

\*high-temperature-resistant version for domestic gas installation